

Feb-Mar 1932

IN THIS ISSUE

NEW PLUG-LESS S-W CONVERTER FOR BROADCAST SETS—HOW TO BUILD

INEXPENSIVE PHONE TRANSMITTERS

EXPERIMENTING WITH QUASI-OPTICAL WAVES

PRACTICAL HINTS ON A.C. OPERATION OF S-W RECEIVERS

THE ALL-WAVE SUPER-BOOSTER AND S. W. CONVERTER

KEYING WITH A "VACUUM CONTACT" RELAY

SINGLE SIDE-BAND TRANSMISSION ON SHORT WAVES

BUILDING A SIMPLE AND INEXPENSIVE "AMATEUR BAND" RECEIVER

SHORT WAVE CRAFT

Edited by
HUGO GERNSBACK

NOW
25¢

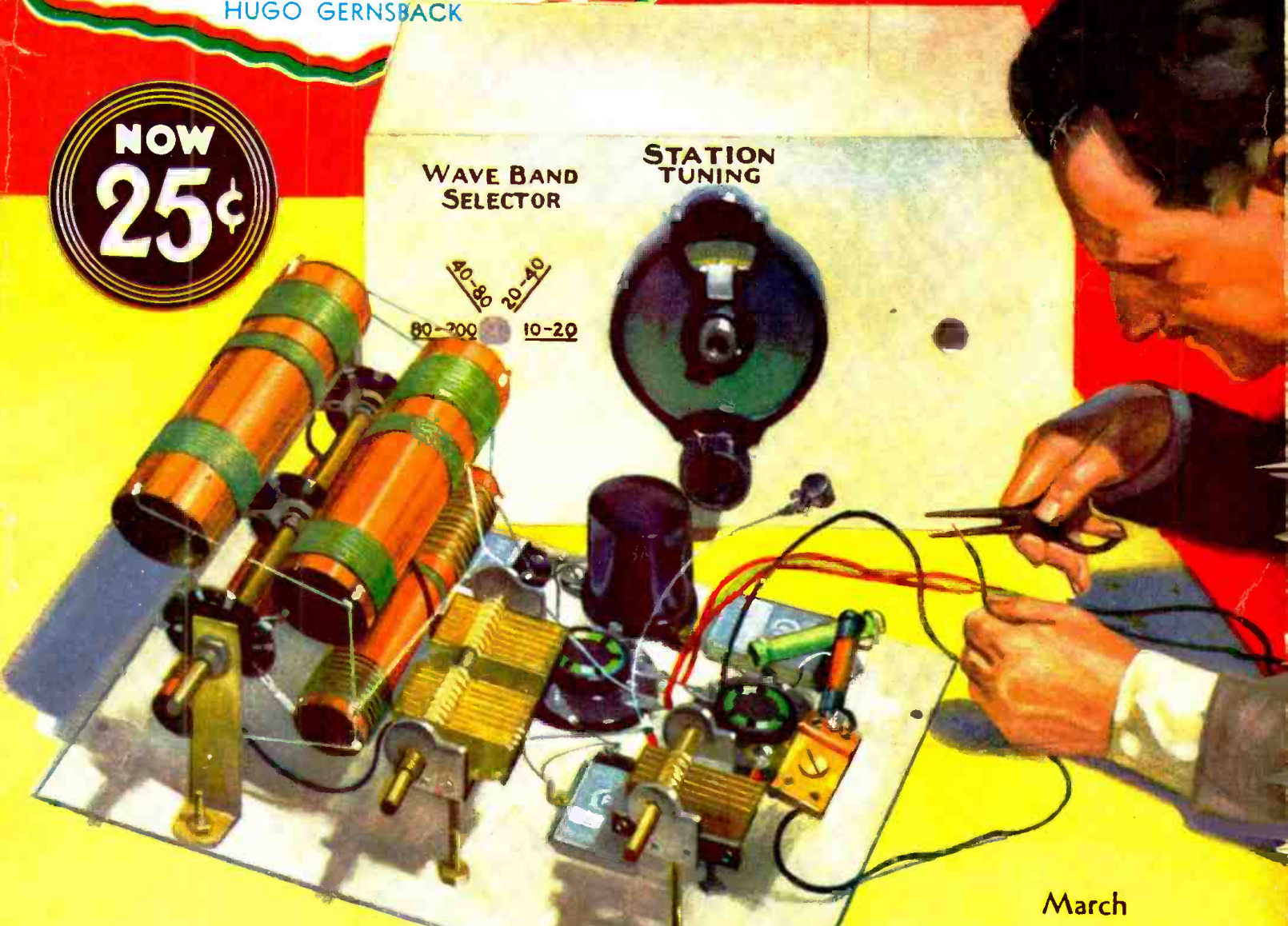

March

This "Converter" Makes Every Broadcast Set A Short Wave Receiver

The COMET

All-Wave

SUPER-HETERODYNE

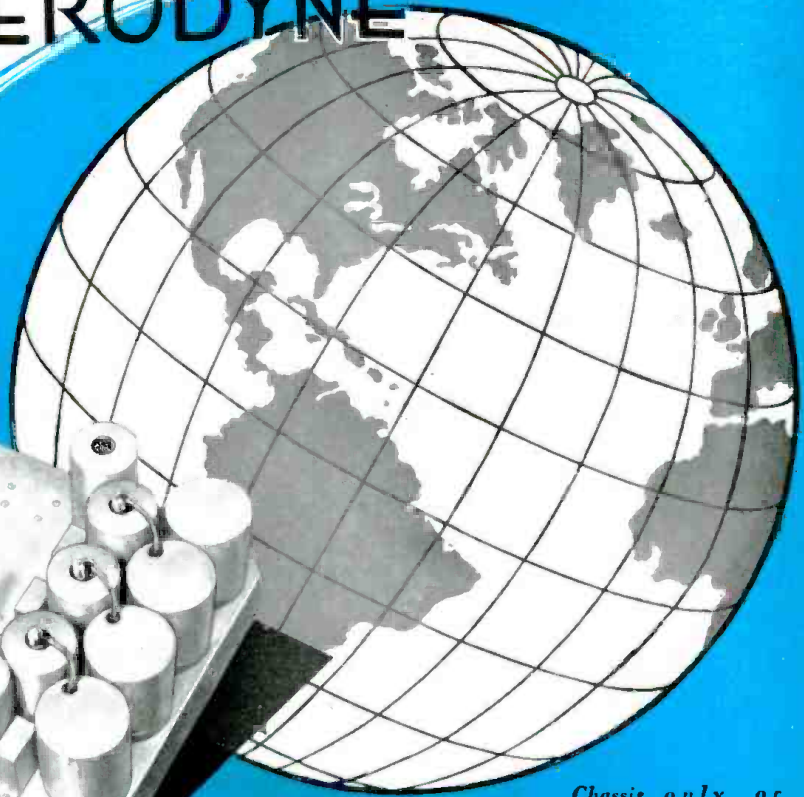
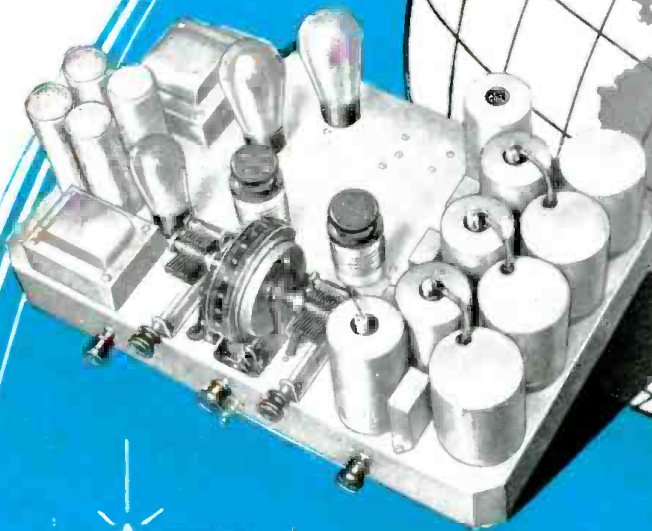

*Chassis only, or
complete in hand-
some walnut console,
with dynamic speaker
and all tubes.*

THE receiver the whole world is waiting for—because it receives the whole world of radio—between 15 and 550 meters.

The Hammarlund "COMET" more than satisfies the professional—delights the amateur—and thrills the broadcast listener.

A super-heterodyne, of course, with exclusive features. A.C. operated—using eight newest type tubes—super-sensitive—super-selective—super-fine, as custom radio always is when built by Hammarlund.

The "COMET" is the perfected all-purpose receiver—for the home—the office—the laboratory—the newspaper—the police department—the airport—the ship at sea, wherever super-efficiency is paramount.

Write Dept. SW-1 for illustrated folder containing list of world short-wave stations.

HAMMARLUND-ROBERTS, INC., 424 W. 33rd St., New York, N. Y.



**CUSTOM
BUILT**

by **HAMMARLUND**

Train *with* R.T.A. *for* Radio Service Work

Important and far-reaching developments in Radio create sudden demand for specially equipped and specially trained Radio Service Men.



*This excellent
set analyzer
and trouble
shooter included
with our course
of training*

MANY skilled Radio Service Men are needed now to service all-electric sets. By becoming a certified R. T. A. Service Man, you can make big money, full time or spare time, and fit yourself for the big-pay opportunities that Radio offers.

We will quickly give you the training you need to qualify as a Radio Service Man . . . certify you . . . furnish you with a marvelous Radio Set Analyzer. This wonder instrument, together with our training, will enable you to compete successfully with experts who have been in the radio business for years. With its help you can quickly diagnose any ailing Radio set. The training we give you will enable you to make necessary analysis and repairs.

Serving as a "radio doctor" with this Radio Set Analyzer is but one of the many easy ways by which we help you make money out of Radio. Wiring rooms for Radio, installing and servicing sets for dealers, building and installing automobile Radio sets, constructing and installing short wave receivers . . . those are a few of the other ways in which our members are cashing in on Radio.

As a member of the Radio Training Association, you receive personal instruction from skilled Radio Engineers. Upon completion of the training, they will advise you personally on any problems which arise in your work. The Association will help you make money in your spare time, increase your pay, or start you in business. The easiest, quickest, best-paying way for you to get into Radio is by joining the Radio Training Association.

This amazing Radio Set Analyzer plus the instructions given you by the Association will transform you into an expert quickly. With it, you can locate troubles in all types of sets, test circuits, measure resistance and condenser capacities, detect defective tubes. Knowing how to make repairs is easy; knowing what the trouble is requires expert knowledge and a Radio Set Analyzer. With this Radio Set Analyzer, you will be able to give expert service and make big money. Possessing this set analyzer and knowing how to use it will be but one of the benefits that will be yours as a member of the R. T. A.

Write for No-Cost Membership Plan

We have worked out a plan whereby a membership enrollment need not cost you a cent. Our thorough training and the valuable Radio set analyzer can be yours. Write at once and find out how easily both of these can be earned.

Now is the time to prepare to be a Radio Service Man. Greater opportunities are opening up right along. For the sake of extra money in your spare time, bigger pay, a business of your own, a position with a future, get in touch with the Radio Training Association of America now.

Send for this No-Cost Membership plan and Free Radio Handbook that will open your eyes as to what Radio has in store for the ambitious man. Don't wait. Do it now.

RADIO TRAINING ASSOCIATION OF AMERICA
Dept. SWC-2 4513 Ravenswood Ave. Chicago, Ill.

Fill Out and Mail Today!

RADIO TRAINING ASSOCIATION OF AMERICA
Dept. SWC-2 4513 Ravenswood Ave., Chicago, Ill.

Gentlemen: Send me details of your No-Cost Membership Enrollment Plan and information on how to learn to make real money in radio quick.

Name

Address

City..... State.....

HUGO GERNSBACK, Editor

H. WINFIELD SECOR, Managing Editor

CONTENTS

FEB.-MAR., 1932

*In This Issue: Prominent Short Wave Authors***Henry - Noack - Nason - Hertzberg - Haidell - Shea - Somerset - Cisin****FEATURES:**

Editorial—Short Wave Peculiarities, by Hugo Gernsback	311
Short Waves Wage War Against Tempests.....	312
Short Waves in the Public Eye.....	313
A First-Class "Ham" Station, by Gordon I. Henry, W9DFR	314
Sliders Do the Trick, by Nelson G. Haas.....	316
The "Best" Short Wave Converter and Receiver, by H. Winfield Secor.....	318
Short Wave Sets at the Berlin Radio Exposition, by Dr. Fritz Noack.....	320
Quasi-Optical Short Waves—Electron Oscillations, by C. H. W. Nason.....	322
Short Wave Converters, by Richard F. Shea, Consulting Engineer, formerly Chief Engineer Pilot Radio and Tube Corp.....	326
The All-Wave Super-Booster, by H. G. Cisin.....	329
"Keying" With New Vacuum Contact, by Herman Kott, Engineering Dept. Burgess Battery Co.	331
A Simple and Inexpensive "Amateur Band" Receiver, by O. G. Nelson.....	333
Circuit of New Pilot All-Wave Receiver.....	335
Single Side-Band Transmission on Short Waves, by C. H. W. Nason.....	336
Hints on A.C. Operation of Short Wave Receivers, by "Bob" Hertzberg.....	339
How Research and Industry Depend on Vibrations, by Dr. Willis R. Whitney, Director of Research Laboratory of General Electric Co.	342
Short-Wave Stations of the World—Latest Revised List	344
When to Listen In, by "Bob" Hertzberg.....	362

SHORT WAVES FOR THE BROADCAST LISTENER:

The "Best" Short Wave Converter.....	318
German Short Wave Converters.....	320
Short Wave Converters—Including Complete Data on Coils, Condensers, and Resistors...	326

A Signal Frequency Amplifier for Short Wave Converters, by E. T. Somerset.....	328
The All-Wave Super-Booster and Converter.....	329
Circuit of the New Pilot All-Wave Receiver.....	335
The International All-Wave Duo Receiver.....	340

SHORT WAVE RECEIVERS:

Sliders Do the Trick.....	316
German Short Wave Receivers.....	320
Quasi-Optical Receivers	322
More About Mr. Doerle's 12,500 Mile Set.....	332
A Simple and Inexpensive "Amateur Band" Receiver	333
The New Pilot All-Wave Receiver.....	335
Hints on A.C. Operation of Short Wave Receivers	339
The International All-Wave Duo Receiver.....	340

SHORT WAVE TRANSMITTERS:

A Transmitter Built for Pleasure, and 1932, by Gordon I. Henry, W9DFR.....	314
Inexpensive Phone Transmitters, by A. H. Haidell	325
"Keying" With New Vacuum Contact.....	331
Single Side-Band Transmission.....	336
Antennas for Ultra Short Wave Transmitters, by Harry D. Hooton.....	338

MISCELLANEOUS:

Famous English Short Wave Laboratory.....	317
English Police Adopt Short Waves.....	317
A New "Bug" Key for the Amateur.....	328
The Propagation of Short Waves.....	330
All Electric, Single-Dial Tuning, Short Wave Super-het	334
New Transmitting Condensers.....	340
Interesting Experiments With the Oscillograph, by Jess M. Reed.....	341
Among the "Hams".....	343
Short Wave Stations of the World, Including "Star" Stations	344
Short Wave Question Box.....	346
Swappers	358

OUR COVER — Illustrates the New "Best" Short Wave Converter, which is fully described with drawings and photos on.....Page 318

SHORT WAVE CRAFT—Bi-monthly. Entered as second class matter May 7, 1930, at the post office at Mount Morris, Illinois, under the act of March 3, 1879. Trademarks and copyrights by permission of H. Gernsback, 98 Park Place, N. Y. C. Text and illustrations of this magazine are copyright and must not be reproduced without permission. SHORT WAVE CRAFT is published on the 15th of every other month. Six numbers per year. Subscription price is \$1.50 a year in the United States and possessions. Canada and foreign countries, \$1.75

a year. Single copies 25c. Address all contributions for publication to Editor, SHORT WAVE CRAFT, 96-98 Park Place, New York, N. Y. Publishers are not responsible for lost manuscripts. Contributions cannot be returned unless authors remit full postage. SHORT WAVE CRAFT is for sale at all principal newsstands in the United States and Canada. European agents: Brentano's, London and Paris. Printed in U. S. A. Make all subscription checks payable to Popular Book Corporation.

London Agent:
HACHETTE & CIE.,
16-17 King William St.,
Charing Cross, W.C.2

Paris Agent::
HACHETTE & CIE.,
111 Rue Reaumur

COPYRIGHT, 1932, BY H. GERNSBACK

Published by **POPULAR BOOK CORPORATION**

HUGO GERNSBACK, President - H. W. SECOR, Vice-President
EMIL GROSSMAN - Director of Advertising
Chicago Adv. Office - L. F. McCLURE, 737 No. Michigan Blvd.

Publication Office, 404 N. Wesley Avenue, Mount Morris, Ill.
Editorial and General Offices, 96-98 Park Place, New York, N. Y.

Australian Agents:
McGILL'S AGENCY,
179 Elizabeth St.,
Melbourne

SAY FELLOWS
 GET INTO
RADIO-TELEVISION
 AND
TALKING PICTURES



Let me tell you how I can quickly train you, NOT by book study, but by actual shop training on real Radio, Television and Talking Picture equipment in 10 WEEKS in the great shops of COYNE in Chicago. Here at Coyne you don't need advanced education or experience and many of my students earn while learning. After graduation I give them lifetime employment service. Here at Coyne too you get individual instruction and you can start anytime.

Radio offers jobs as Designer, inspector and Tester, Salesman, and in installation work, operator of a broadcasting station, wireless operator on a ship, with Talking Pictures theatres - with Television Laboratories and studios. Television alone will soon be calling for thousands of trained men. Come to Coyne here in Chicago and prepare for one of

these jobs the quick and practical way BY ACTUAL SHOP WORK.

It's a shame for any fellow to go thru life as an untrained man working at small pay, and never even sure of a steady job, and when he does work working at any old price they want to pay him.

You can avoid this. You can be a trained man and have a real future. Mail the coupon today and I'll send you my big Free book and tell you how you can be a success just as hundreds of my graduates are achieving.

H. C. LEWIS, President
 Radio Division, **COYNE ELECTRICAL SCHOOL**
 500 S. Paulina St., Dept. 119-2K, Chicago, Ill.
 Send me your Big Free Radio and Television Book, and tell me how I too can make a success in Radio.

Name

Address

City.....State.....

WORLD'S BEST RADIO BOOKS



ORDER DIRECT FROM THIS PAGE

WE herewith present to the readers of **SHORT WAVE CRAFT** the most complete collection of recent important radio books. We have, after an exhaustive study, selected these volumes because they represent the foremost radio books of their kind in print today. There is such a great variety that we are sure it will satisfy any taste as well as any requirement that the student of radio might have.

We publish no catalogue and ask you to be kind enough to order direct from this page. Prompt shipments will be made to you direct from the publishers. We merely act as a clearing house for a number of radio book publishers and **OUR PRICES ARE AS LOW OR LOWER THAN WILL BE FOUND ANYWHERE.** Prompt shipments will be made. Remit by money order or certified check. If you send cash, be sure to register it. If you wish to get any other radio book, please write us.

EXPERIMENTAL RADIO, by R. R. Ramsey, Professor of Physics, Indiana University. Cloth covers, size 7 1/2 x 5 1/2", 256 pages, 108 illustrations. Price, postpaid **\$2.75**

This book by Professor Ramsey is written in the nature of an experimental radio course and contains 128 experiments, illustrated and described in a clear and interesting style. The experiments cover such valuable subjects as: A test on a loud speaker; the impedance of coils; construction of a filter, screen grid tube; beat note audio oscillator; etc.

PRINCIPLES OF RADIO COMMUNICATION, by J. H. Morecroft, Prof. of Electrical Engineering, Columbia University. Cloth covers, size 9 1/2 x 6", 988 pages. Profusely illustrated. Price **\$7.50**

A radio classic. Indeed, it is Professor Morecroft's very complete text-book which covers such important radio phenomena as: the action in condensers; self and mutual induction in a circuit; phase and phase difference; effect of condensers and coils on wave shape; resonance frequency of coupled circuits; skin effect in coils; antenna resistance; transformers; vacuum tubes; radio frequency alternators; modulation and circuits; amplifiers and filters.

RADIO TRAFFIC MANUAL AND OPERATING REGULATIONS, by R. L. Duncan and C. E. Drew. Flexible covers, size 9 1/2 x 6". Price **\$2.00**

This valuable handbook starts off with instructions on how to learn the code in considerable detail, with a list of abbreviations. Then comes operating rules and regulations of the Radiomarine Corporation of America with operators' report forms; followed by the rules of the International Radiotelegraph Convention; the United States Radio Act of 1927; the Ship Act of 1912; etc.

PHOTOCELLS AND THEIR APPLICATION, by V. K. Zworckin, E.E., Ph.D., and E. D. Wilson, Ph.D. Cloth covers, size 5 1/2 x 8", 210 pages, 97 illustrations. Price **\$2.50**

Photocells today occupy a very important place in radio and talking pictures, as well as other branches of applied science, and these two experts have provided the very latest information as to the action taking place in various types of photocells. The theory on which these different cells operate, including color sensitivity, together with amplifier and scanning discs used in picture as well as television transmission, etc.

PRINCIPLES OF RADIO, by Keith Henney, M.A. Cloth covers, size 8 1/2 x 5 1/2", 478 pages, 306 illustrations. Price **\$3.50**

The author is well known in radio and he has here provided a very complete and clearly written discussion of radio circuits and apparatus, including such important topics as: condensers; transformers; determination of inductance;

vacuum tube action, including Screen Grid and Pentode; wave meters; their calibration and use; modulation; amplifiers; long wave receivers; and different types of rectifiers.

HOW TO PASS U. S. GOVERNMENT RADIO LICENSE EXAMINATIONS, by R. L. Duncan and C. E. Drew. Flexible covers, size 9 1/2 x 7", 170 pages, 92 illustrations, appendix. Price **\$2.00**

The authors are thoroughly conversant with their subject and all of the most important information including look-ups; types of antennae and receivers with wiring diagrams of both small and large receivers and transmitters of commercial type, including ship sets are given.

RADIO RECEIVING TUBES, by Moyer and Wustrel. Cloth covers, size 7 1/2 x 5 1/2", 298 pages, 181 illustrations. Price **\$2.50**

No radio student or operator can do without this authoritative book on the radio vacuum tube. The various chapters include construction of vacuum tubes; electrical fundamentals; elementary action taking place in the vacuum tube, with graphs; reactivation of tubes; testing of tubes including determination of amplification factor; plate resistance; grid resistance, etc.

PRACTICAL RADIO—INCLUDING THE TESTING OF RADIO RECEIVING SETS, by James A. Moyer, S.R., A.M., and John F. Wustrel. Cloth covers, size 8 1/2 x 5 1/2", 378 pages, 223 illustrations. Price **\$2.50**

Everyone will find this volume of the utmost practical value as the authors have explained in text and diagrams, for the practically-minded student, such interesting subjects as telephone receivers and crystal sets; various types of aerials; current sources for vacuum tubes; audio and radio frequency amplification with hookups; loud speakers and how they work; various radio receiving sets with diagrams and just how they work

PRACTICAL RADIO CONSTRUCTION AND REPAIRING, by J. A. Moyer, S.R., A.M., and J. F. Wustrel. Cloth covers, size 8 1/2 x 5 1/2", 354 pages, 163 illustrations. Price... **\$2.50**

This handbook is one that every radio set tester and general student will want to read carefully. These experts have given a very complete description of instruments used to test and repair modern radio sets, together with complete diagrams of many modern receiving sets, with explanations on how to test the radio and audio frequency stages for faults.

ELEMENTS OF RADIO COMMUNICATION, by Professor John H. Morecroft. Cloth covers, size 9 1/2 x 6", 270 pages, 170 illustrations. Price... **\$3.00**

Professor Morecroft explains in an authoritative and clear manner such important radio phenomena as: current flow in circuits containing capacity and inductance; propagation of radio waves; vacuum tubes as detectors and amplifiers; fading of radio waves and its causes; neutralization; superheterodynes for short waves, etc.; audio frequency amplifiers; how filters work, etc.

RADIO TELEGRAPHY AND TELEPHONY, by R. L. Duncan and C. E. Drew. Cloth covers, size 9 1/2 x 6", 950 pages. Price **\$7.50**

This 950 page book forms indeed a most complete treatise on radio facts. The authors treat thoroughly the magnetic circuit; Ohm's law; transformers and induction; motor generators and starters; storage batteries; alternating currents; capacity and inductance formulae. Vacuum tubes as detectors and amplifiers; oscillographs; radio compass; wavelength measurements and short wave receivers.

RADIO SERVICE MAN'S HANDBOOK WITH ADDENDA DATA SHEETS, Flexible covers, size 9 1/2 x 6", 200 pages, 200 illustrations. Price, prepaid **\$1.95**

This remarkable book contains several hundred illustrations with wiring diagrams and charts covering every conceivable subject, including radio sets, tubes, etc. The book is strictly up-to-date and contains the newest Practical information which every radio man absolutely must have.

OFFICIAL RADIO SERVICE MANUAL, by Hugo Gernsback and Clyde Fitch. Flexible covers, size 9 1/2 x 6", over 1,000 illustrations, 352 pages. Price, prepaid **\$2.98**

Commercial wiring diagrams for all the regularly manufactured receiving sets are included in this manual and no radio service man or student who builds and repairs radio sets can be without this tremendously useful compilation of circuits and their descriptions. This book is worth \$100.00 to anyone who has a use for it. The Manual is indexed so that any commercial receiving circuit can be found instantly. One of the most valuable radio books ever published.

Howtoorder

We cannot make C.O.D. shipments. Our prices are net, as shown on this page. You will note that some of the books include postage. Those that do not will be shipped by express collect if you do not wish to include a sufficient amount of postage.

FUNDAMENTALS OF RADIO, by R. R. Ramsey, Professor of Physics, Indiana University. Cloth covers, size 9 1/2 x 6", 372 pages, illustrated. Price, prepaid **\$3.50**

Dr. Ramsey gives us a very refreshing treatment of the fundamentals of radio, including battery and dynamo action; alternating currents; inductance; vacuum tube constants; aerials of different kinds and how they operate; radio frequency instruments and apparatus; audio amplification and receivers in general.

RADIO TROUBLE SHOOTING, by Emor R. Haan, E.E. Flexible covers, size 6 x 9", 323 pages, 257 illustrations. Price **\$3.00**

This is a well illustrated and intensely practical handbook for all radio service men and operators, as well as set builders and testers. Some of the practical problems illustrated and discussed are: interference and noise problems—how to locate and remedy them; antenna circuit troubles and their effect on radio; batteries, chargers and eliminators.

DRAKE'S RADIO CYCLOPEDIA, by H. P. Manly. Cloth covers, size 8 x 9", 1035 pages, profusely illustrated. Price **\$6.00**

This massive cyclopedia covers radio apparatus—its operation and maintenance, the various subjects being alphabetically arranged. There are 1735 subjects in alphabetical order ranging from A-battery to zero-beat. This volume contains 1110 illustrations, diagrams, etc. There are 411 illustrations and articles on the building and deslating of radio sets, alone; 110 articles with 383 illustrations on the methods of repair, service and adjustment of radio sets.

S. GERNSBACK'S RADIO ENCYCLOPEDIA, by S. Gernsback. Stiff leatherette covers, size 9 1/2 x 7", 168 pages, profusely illustrated. Price **\$1.65**

Radio apparatus, inventors and terms are all illustrated and described in this remarkable book which required the efforts of several engineers in its compilation. The subjects are alphabetically arranged and the illustrations are especially fine and clear.

TELEVISION TO-DAY AND TOMORROW, by S. A. Moseley and H. J. B. Chapple. Cloth covers, size 8 1/2 x 5 1/2", 130 pages, profusely illustrated. Price, prepaid **\$2.50**

This up-to-the-minute work on television describes in detail the apparatus used by Baird. The student will learn all about scanning discs; the best type of motor; reverse effects and how to overcome them; isochronism and synchronization; various ways of synchronizing the receiving discs; photocells and neon tubes; radio receivers for television signals; noctovision.

SOUND PICTURES AND TROUBLE SHOOTER'S MANUAL, by Cameron and Rider. Cloth covers, size 8 1/2 x 5 1/2", 1120 pages, profusely illustrated. Price **\$7.50**

This useful volume will appeal to all radio as well as "talkie" trouble-shooters. The first chapters deal with fundamentals of electrical circuits, including Ohm's law, A.C. and D.C. circuits, rectifiers, amplifiers, mixers and faders; various types of loud speakers and how to arrange them; photocells; electric motors; various types of talkie projectors; also commercial amplifiers with diagrams are given.

RIDING THE AIR WAVES. WITH ERIC PALMER, JR. by himself. Cloth covers, size 7 1/2 x 5 1/2", 328 pages. Price **\$2.00**

Short wave fans cannot miss reading this highly entertaining and informative book which tells the story of youthful Mr. Palmer and his remarkable achievements in amateur radio. "Around the World with 5 Watts" and many other interesting subjects appear between the covers of this book.

A POPULAR GUIDE TO RADIO by B. Francis Dashiell. Cloth covers, size 5 1/2 x 8 1/2", 286 pages, profusely illustrated. Price, prepaid **\$3.50**

The author starts off with an excellent section on electricity and magnetism; the use of radio aerials and grounds; the fundamental principles of radio; the electron tube and crystal rectifiers—how they work; the principle of radio amplification; radio inductance coils and condensers; fundamental radio receiving circuits; electrical reproduction of sound; the atmosphere and radio phenomena, etc.

RADIO VISION, by C. Francis Jenkins. Cloth covers, size 9 1/2 x 6", 111 pages, profusely illustrated. Price, prepaid **\$1.25**

A beautifully printed and interesting illustrated history of transmission of images by radio; particularly covering the apparatus and successful demonstrations of the Jenkins system. Other apparatus illustrated and discussed are the Braun tube receiver; the H. C. A. Photo-radio apparatus; the A. T. & T. Company system; and the Bell machine.

RADIO MOVIES AND TELEVISION, by C. Francis Jenkins. Cloth covers, size 9 1/2 x 6", 144 pages, profusely illustrated. Price, prepaid **\$2.50**

An absorbing history, handsomely illustrated, of the Jenkins system of transmitting and receiving movies "via radio." One of the chapters gives constructional details and drawings for building your own Radiovisor or machine for making the radio movies visible in your home. Diagrams of amplifiers are given, with some other very valuable information.



Darkened areas show the foreign countries in which Scott All-Wave Receivers are depended on for radio contact with the rest of the world.

Not only in America, is the Scott All-Wave supplying an entirely new concept of radio performance. In other lands too—in difficult spots, this receiver is doing equally sensational work. For instance, atmospheric conditions are so bad in the Canary Islands that reception there has always been considered almost impossible. Scott All-Wave Receivers located in the Canary Islands, bring in stations 9,000 and 10,000 miles away with good clarity and volume. But it is the underlying reason for such amazing performance that interests you!

The Scott All-Wave Receiver is so powerful and so sensitive, that when operated with the volume turned way down below the noise level, there is still more than enough sensitivity to give ample loud speaker reproduction of signals originating 9,000 and 10,000 miles away. This is one of the main reasons why Scott All-Wave Receivers are being used with complete success in 63 foreign countries today—why Scott owners in this country can tune 'round the world with their receivers whenever they choose—and why YOU will want a Scott!

What is the Difference that makes the Scott All-Wave so much Better?

The Scott All-Wave is not a factory product. It is built in the laboratory by experts and to laboratory exactness. Physical measurements are by the micrometer—electrical measurements are computed to the smallest fractions—each nut and bolt, each wire, and each operation, no matter how small, is performed by a man with a thorough technical understanding of radio.

The result is a precision-built receiver capable of doing things that factory-built receivers can never hope to do. The result is sensitivity so great that Chicago owners can listen to G5SW, Chelmsford, England; 12RO, Rome; VK3ME, Sydney; HRB, Honduras; and many others any day they choose. The result is also perfect 10 Kilocycle selectivity. No "cross talk." And the resulting tone is nothing short of downright realism—full, round and natural.

These Foreign Countries Now Served by SCOTT ALL-WAVE RECEIVERS

- 1. ALASKA
- 2. ARGENTINE
- 3. BARBADOS
- 4. BELGIUM
- 5. BERMUDA
- 6. BRAZIL
- 7. BRITISH GUIANA
- 8. BRITISH OCEANIA
- 9. CANADA
- 10. CANAL ZONE
- 11. CANARY ISLANDS
- 12. CHILE
- 13. CUBA
- 14. COLOMBIA
- 15. COSTA RICA
- 16. CUBA
- 17. CZECHOSLOVAKIA
- 18. DOMINICAN REPUBLIC
- 19. ECUADOR
- 20. EGYPT
- 21. ENGLAND
- 22. FINLAND
- 23. FRANCE
- 24. FRENCH WEST AFRICA
- 25. FRENCH WEST INDIES
- 26. GERMANY
- 27. GREECE
- 28. GUATEMALA
- 29. HAITI
- 30. HAWAII
- 31. HONDURAS
- 32. INDIA
- 33. ITALY
- 34. JAMAICA
- 35. JAPAN
- 36. MALTA
- 37. MEXICO
- 38. NETHERLANDS
- 39. NETHERLAND WEST INDIES
- 40. NETHERLAND EAST INDIES
- 41. NEW ZEALAND
- 42. NICARAGUA
- 43. NORTH AFRICA
- 44. NORWAY
- 45. PANAMA
- 46. PERU
- 47. PHILIPPINE ISLANDS
- 48. POLAND
- 49. PORTO RICO
- 50. PORTUGAL
- 51. SALVADOR
- 52. SAMOA ISLANDS
- 53. SCOTLAND
- 54. SIAM
- 55. SOUTHERN Rhodesia
- 56. SPAIN
- 57. SWITZERLAND
- 58. TRINIDAD
- 59. UNION SOUTH AFRICA
- 60. URUGUAY
- 61. VENEZUELA
- 62. WALES
- 63. YUGOSLAVIA

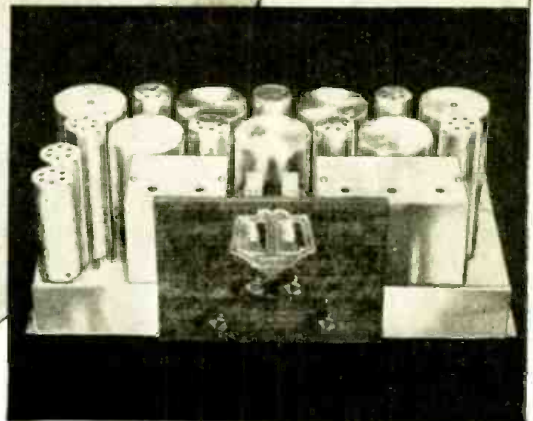

Sturdy Construction Protects Precision Adjustments

The precision work, which gives the Scott All-Wave its supremacy is assured constancy by the heavy steel chassis—rigid as a bridge, and chromium plated to protect it from deterioration. The All-Wave chassis is so sturdily built that it is unconditionally guaranteed for five full years. Any part proving defective within that time will be replaced free of charge.

Write for Full Details

Surely, a 15-550 meter receiver that will satisfy the exacting requirements of 63 different foreign countries, will suit your needs better than any other. Surely, a receiver that is tested on reception from London and Rome before shipping is the receiver you would rather own. Mail coupon today for full particulars of the Scott All-Wave Receiver. (Name and address of Scott owner in any foreign country, sent on request).

CLIP

The E. H. Scott Radio Laboratories, Inc.
 4450 Ravenswood Ave., Dept. SWC-2,
 Chicago, Illinois

Send me full details of the Scott All-Wave, 15-550 meter superheterodyne.

Check here if Set Builder Dealer Radio DXer

Name.....

Street.....

Town.....State.....

The E. H. SCOTT RADIO LABORATORIES, Inc.
 FORMERLY SCOTT TRANSFORMER CO.
 4450 Ravenswood Avenue, Dept. SWC-2, Chicago, Illinois

Super Power

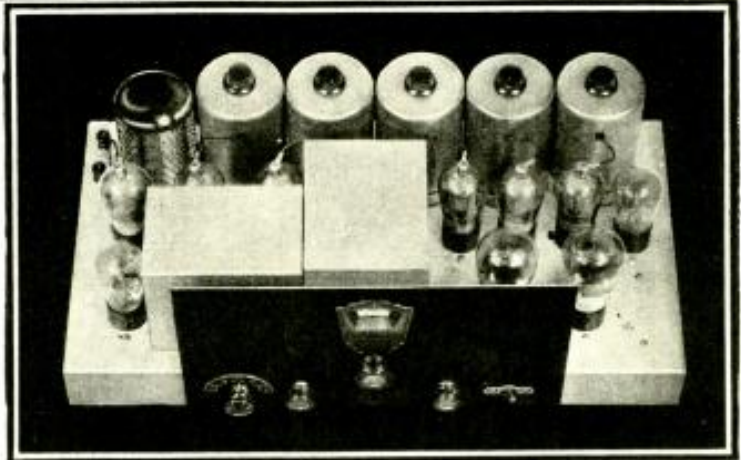

insures

World-Wide Performance- 15 TO 550 METERS-NO PLUG-IN COILS

THE phenomenal ability of Lincoln DeLuxe receivers to receive stations from every corner of the globe is largely due to Lincoln Super-Power. The tremendous gain of Lincoln's highly efficient circuit opens a new field for the radio listener. National and international programs, fascinating foreign broadcasts, short-waves, air-mail, trans-Atlantic phone,—these and many other features are available to the Lincoln owner.

From 15 to 550 Meters at the Touch of a Switch

One of the outstanding advances in radio design of recent years is the elimination of plug-in coils for short-wave reception. Having designed the DeLuxe to tune from 15 to 550 meters, Lincoln engineers perfected an extremely efficient and ingenious design whereby a small no-capacity selector switch makes the contacts formerly made by the coil prong and socket contact. A Lincoln owner may change from broadcast to any one of four short-wave bands by merely turning the selector switch.

A New Conception of Short-Wave Reception

The application of Lincoln's mighty power to the reception of short-waves produces truly amazing results. Stations half-way around the world come in with clock like regularity. Lincoln enthusiasts in the central states have

repeatedly reported *broadcast* reception of many trans-Pacific stations. The tremendous amplification of the highly engineered Lincoln circuit is always perfectly controlled in a channel less than 10 K.C. wide. A letter from Alaska reports reception of Mexico, Nebraska and Vancouver, B. C., all three stations 5 K.C. apart!

Full, Rich, Life-Like Lincoln Tone

Lincoln tone is a revelation of purity and fidelity. Lincoln experts have designed an audio system that, with either radio or phonograph pick-up input, delivers tone of astonishing richness and realism. Artificial tone compensators or control devices are not required to bring out the natural vivid tone of the living artist.

DeLuxe DC-SW-10, Battery Model, Is Extremely Efficient

The Lincoln DeLuxe DC-SW-10 is the battery model version of the famous DeLuxe SW-32 described above. Taking advantage of the new low drain 2 volt tubes, the DC-SW-10, when operated from an adequate battery source, provides exceptionally quiet, crystal clear reception of both broadcast and short-waves. This model, although intended for rural or unelectrified areas, is finding increasing favor in congested city communities because of its absolute freedom from line noise and clear life-like tone quality.

Clip and Mail NOW!

LINCOLN DE LUXE - SW-32

LINCOLN RADIO CORPORATION

Dept. SWC-5, 329 S. Wood St., CHICAGO, ILL.

Please send descriptive literature to NAME.....

ADDRESS..... CITY..... STATE.....



SHORT WAVE PECULIARITIES

By HUGO GERNSBACK

WHILE short waves have grown by leaps and bounds during the past few years, and while it may be said that there is a small boom in short waves right now, due to the tremendous public interest in them, it is well to discuss here some of their peculiarities in general.

To many readers, the few words I have to say will not be news; the information will be new to those who are now starting in the game, and particularly that class of short wave enthusiasts who are starting in with a *short wave converter*.

At the outset, let us be frank and admit that the short wave converter, which is now an increasing vogue, is a temperamental instrument, and is not as efficient as a "pure" short wave set. The reason for the odd behavior of the converter at times must be ascribed direct to the broadcast set in conjunction with which it is used.

The Short Wave Converter

The idea of the converter, as its name implies, is to convert the ordinary broadcast set to a short wave set. If the broadcast set is exceedingly sensitive or not fully shielded, it is then necessary to adjust it in such a way that it is tuned entirely out of the broadcast band, and for most efficient operation, the setting therefor would be below 1500 kilocycles (200 meters). At any other setting, there is likely to be interference between the broadcast set and the converter. If the broadcast set is not very sensitive, then, of course, it may be said that the addition of the converter will not make it any more sensitive; the results, therefore, are not apt to be very good, and the novice is likely to blame the poor operation on the converter, when the fault really lies with the broadcast receiver itself. It may be said, therefore, unless you have a good sensitive broadcast set, that brings in long distance regularly, the addition of the converter will not be a huge success.

If the broadcast set, on the other hand, is a good one, and is very sensitive, particularly on "DX" stations, and still you do not get far-away stations through the converter, then it may be that the tubes or the converter are not good and should be switched around. Often, a change of tubes in a converter has achieved wonders.

Another complaint we often hear from the novice who uses a converter, is that he can only get one or two foreign stations and nothing else. The reason for this is simple and often encountered among the inexperienced or novices, who should study the following points and remember them well:

Firstly, there is such a thing as the *best time of the day* for short waves. In most parts of this country, very poor results on any short wave set is the rule between the hours of 8 and 12 Midnight. The best results are in the early morning hours between 5 and 8 A. M. and in the afternoons between 1 and 5, speaking generally. There are, of course, some exceptions to this.

Remember that short waves come in best, from long distances, when the sun has gone down at the point of transmission. For instance, listening on the eastern seaboard to "Big Ben" of London, transmitted through Station G5SW, the best time will be about 5 o'clock in the afternoon. This time is 10 P. M. for London.

Another point to remember is that every receiving location is an entity by itself. This is particularly so in large cities, but is not so serious in the country. In large cities,

we have peculiarities in "dead spots" and poor reception from short waves due to "absorption" by large steel structures, and other freak conditions which no one can foretell. In the open country, conditions usually are vastly better, but in the city short wave receiving conditions are "spotty" and must be studied. Sometimes, the change of an aerial in a poor location will work wonders.

While it may be said as a rule that a long aerial is no more efficient than a short one for short waves, again there are exceptions. We have seen locations where receiving conditions were exceedingly poor with a 50-ft. aerial, and a 200-ft. aerial achieved wonders. Of course, when using long aerials for short waves, it is necessary to put a small condenser in series with the set for best results. This is true even if a broadcast set is used in connection with a converter.

If the right type of condenser is used, which may vary from .00025 to .0001, the signals in the broadcast set will be a great deal stronger, and if the set is a good one, it will actually not tune any broader due to the insertion of the condenser, but the results in the converter will be vastly improved.

There is still one more point to be considered when using a converter or any other short wave set and this point has particular reference to cities. I refer to the irritating interference set up by electric elevators, passing automobiles, and other electro-mechanical appliances which send off or radiate radio frequency waves and which come in over the aerial, and which frequently nothing will stop. Such interference must be taken care of at the source.

If you are sure that it is the elevator in the building, the electric power company may remedy it by installing a "filter system" and do away with the annoyance. As far as passing automobiles are concerned, nothing much can be done now.

But I have seen some exceptions to this condition also. A friend of ours operates a short wave converter in the City of New York, surrounded by steel frame buildings on every side, and he uses no aerial at all. With his particular scheme no ground is used at all, the "ground" in reality being the electric light circuit connection, which provides sufficient "ground." For an aerial he uses the "radiator" system of the building, but no metallic connection is used with the radiator. A small condenser is used in the lead-wire, which takes the place of the aerial, and the arrangement works surprisingly well.

"Listening Time" Is Important

Similar tricks to these may be worked out with good results; the use, for instance, of bed springs or indoor aerials, which in some localities frequently give very good results.

And finally, before you blame the converter, remember a most important point: You may be trying to tune in short waves when no one is sending. The best set in the world would not bring in signals that do not exist! Be patient and try out your converter at different times of the day or night before you condemn it; and then also remember the most important point of all and that is—you must tune exceedingly slowly because a hair-breadth of variation is likely to tune in or out a particular station.

Most short waves come in weakly, with not any too much power behind them. For that reason, I always recommend the use of headphones when listening for short waves, because it is the exception when you get a signal loud enough to work a loud-speaker, unless you are using an exceedingly powerful receiving set.

SHORT WAVE CRAFT IS PUBLISHED ON THE 15th OF EVERY OTHER MONTH

THE NEXT ISSUE COMES OUT MARCH 15th

SHORT WAVES *Wage* WAR

AGAINST TEMPESTS

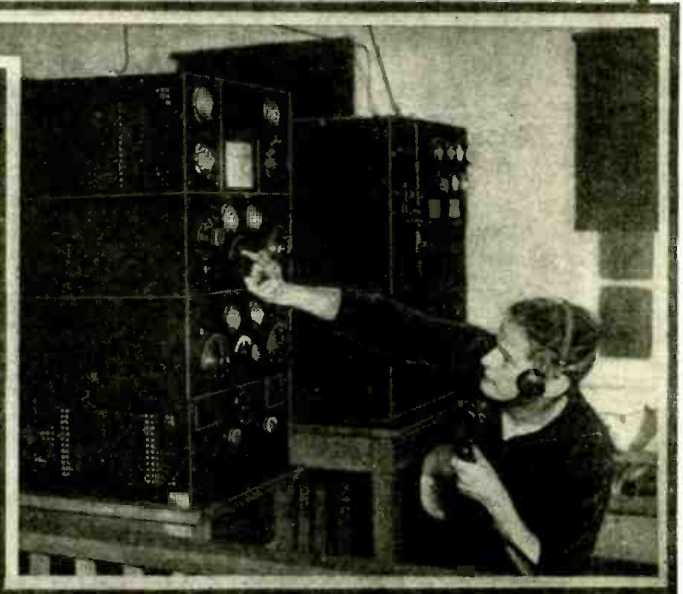
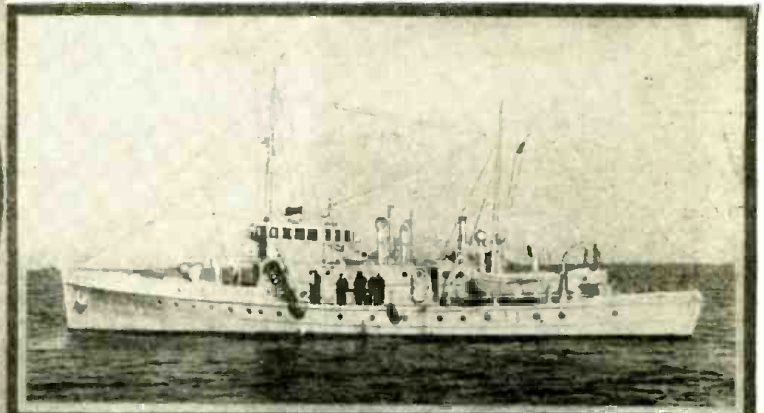

Top picture—Shooting a line to foundering vessel. Below—The little Coast Guard boat has its short wave equipment.

Top right—A typical 125-foot patrol in the U. S. Coast Guard Service. The radio quarters are located in the rear of the pilot house. Radio man at Coast Guard Base 2, Clifton, Staten Island, N. Y., about to talk to a Coast Guard Boat "out at sea." He is pressing the starting button on the short-wave transmitter.

IN this year of peace there are some 11,000 U. S. government men at war. These soldiers are sailors and their battle is with the sea. The sea is not exactly their enemy. They must love it to spend so much of their lives on it. But their business is to fight it, and this is a warfare carried on not to destroy human life but to save it.

These are the men of the United States Coast Guard who stand watch day and night over life, limb and property along the thousands of miles of U. S. waterfront, both coastal and inland. Their traditions go back to 1790, when George Washington put the first cutter into service. That cutter has grown into a flotilla numbering 35 cutters, 18 destroyers, 287 patrol boats, and scores of other craft; 8 shanties built on the Jersey coast in 1848 have grown into 270 stations that dot American shores.

The implements of this unique war-

fare are themselves unique—guns that eject not death but a lifeline, pants of canvas called breeches buoys that make the last path to safety, Coston lights that flare red in the hands of the watchful beach patrol and warn a vessel of danger.

Use New Weapons

The sea is the same as it ever was but the weapons for fighting it have been constantly improved. Steel has replaced wood, and steam the white spread of canvas. Now airplanes begin to range over coastal waters. Even the telephone has put to sea and the work of saving lives becomes business-like.

In the tiny radio shack of the *Diligence*, 125-foot patrol boat, you hear the vessel in conversation. "Diligence . . . Diligence . . ." the words come chanting out of the air, "from Rockaway . . . from Rockaway . . . motor boat in dis-

truss off Sandy Hook." And later the operator, like a man in his office, picks up his microphone and replies, "Rockaway . . . Rockaway . . . from the Diligence . . . from the Diligence . . . motor boat in tow . . . passengers safe on board."

In the shack are the vessels' vocal chords. Engineers of the Bell Telephone Laboratories have designed for Western Electric Company a condensed broadcasting station which might fit into a large size suit case. It works on *short waves* and the Coast Guard has its own private channel which does not interfere with commercial broadcasting. The receiving set is still smaller.

More than 300 Coast Guard vessels and 24 land stations are now equipped with Western Electric radiophone. On land the Coast Guard operates nearly 4,000 miles of line and 569 miles of submarine cable.

SHORT WAVES IN THE PUBLIC EYE

Popular short wave events: a new British short wave converter; short waves link Follies' beauty with Fatherland; short waves on largest plane and auxiliary broadcast pick up.



NEW 7-METER CONVERTER

PHOTO above shows a new English 7-meter short wave converter without its cabinet. As the B.B.C., is broadcasting experimentally on seven meters this converter will prove very useful indeed; by this means it becomes possible to pick up short waves in the neighborhood of seven meters with any broadcast receiver, such as a 200 to 500 meter apparatus. The converter, acting in conjunction with the regular broadcast receiver, serves to act as a frequency changer. It was invented by an English inventor, G. T. Kelsey.

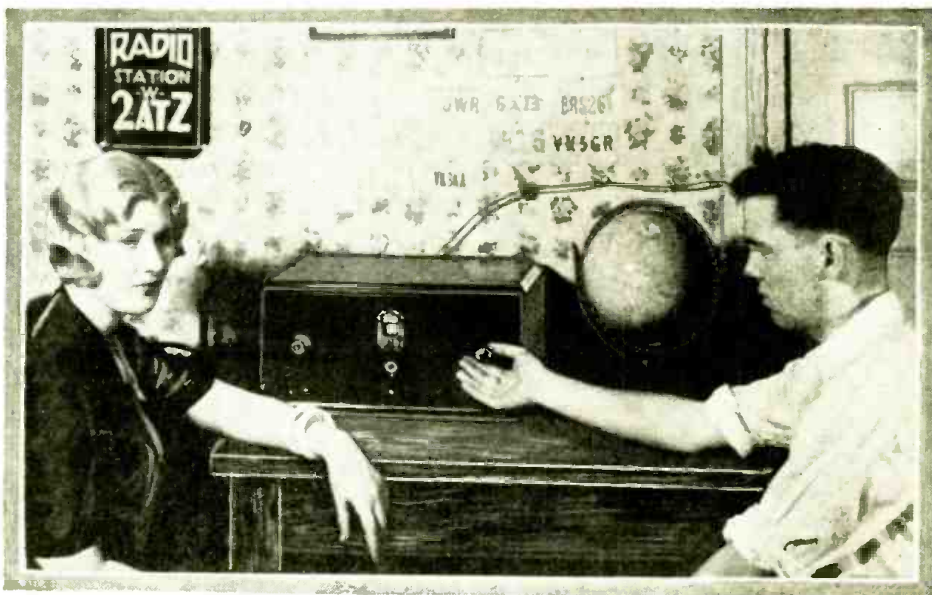

"BABY" BROADCASTER

FOLLIES' BEAUTY HEARS HOMETOWN ON SHORT WAVES

MISS FRIEDA MIERSE, one of the glorified girls of the Ziegfeld Follies, and the "Miss New York" of a few seasons ago, recently had the pleasure of listening to a program from Germany, where her parents were born, thanks to short waves and the skill of Eric Palmer, Jr., here shown tuning in the program.

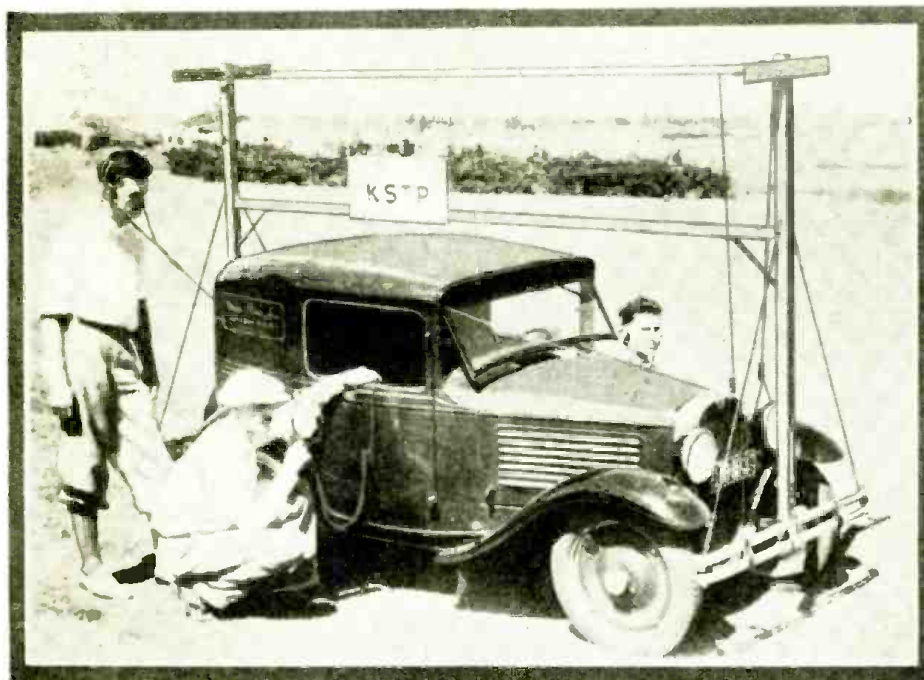

ABOVE we see what is possibly one of the smallest commercial broadcasting sets ever built—a real "baby" broadcaster to be sure. The "baby" Austin car has two antenna masts erected at the front and rear of the car; this portable broadcast "pick-up" proves ideal for relaying sporting events.

"DO-X" SHORT WAVE SET

THE handsome radio operator with his fingers on the key of the short wave transmitter, illustrated at right, is none other than Henry Kiel, chief radio operator of the famous Do-X plane, on its recent flight across the ocean and up the coast of the Americas to New York.



A FIRST CLASS

With "A Transmitter Built
By GORDON I. HENRY, W9DFR

Here's an interesting story by a real "Ham" radio operator which will interest other "Hams" and all those who hope to be. Of course you can break in to the amateur operating game with a \$15.00 transmitter, but Mr. Henry shows us what can be done in building a real "Prof" looking S-W transmitter at a reasonable cost—a goal for every ambitious amateur.



GORDON I. HENRY, born December 5, 1909, at Creston, Iowa. Graduated from Creston High School in 1925. Amateur station and operator's license issued in 1924 with the call W9DFR (just 9DFR at that time) which has been held continuously since that date with the same call letters. Commercial license issued in 1927. Operator at WOW, Omaha, for one year, leaving to join the American Broadcasting Company. When ABC went into bankruptcy joined the technical staff of KOIL, where is still employed. Entered Creighton University in 1930 and enrolled there at present. Member of the Institute of Radio Engineers since 1927. Member of the American Radio Relay League since 1925. Official Relay Station since 1926. Army-Amateur alternate state control station for state of Nebraska. Served five years in the U.S.N.R. as Radioman 2c, at present Acting Unit Commander of the Volunteer Communication Unit in Omaha and also member of the R.O.T.C. Unit at Creighton University.

SINCE 1923 changes and improvements have come so fast in high-frequency radio transmitters that the amateur or "ham" who has kept apace with developments, has been forced to spend considerable time and money. The author, in keeping "W9DFR" on the air with a somewhat modern note, has built no less than twenty different transmitters during the last seven years. The power used ranged anywhere from a receiving tube with a few watts input, to a one-kilowatt "jug" with five hundred watts output. While none of these transmitters has been perfect in every detail, that in use at present and described in this article is about as good a

compromise as any "ham" could wish for, unless he happens to be a young millionaire. As I am rather handicapped by a lack of "iron men" I developed this transmitter along lines of low power, without suffering too great a reduction of foreign contacts.

Building the Frame

Each stage and the "power pack" is taken up separately in the description. The entire unit is mounted in an oak frame, measuring five and one-half feet high and eighteen inches square. Don't throw up your hands in horror at the thought of such a large panel. Pressed board admirably serves the purpose, and the cost is only a couple of dollars. After all holes have been drilled and cut, sand it lightly and paint with an old phonograph record dissolved in alcohol. It will take a day or so for the alcohol to dissolve the record but, when it is about the thickness of a good paint, you have a good insulating paint that brushes on nicely. Give the entire framework as well as the panel two coats, and a dull finish results that will not show fingerprints. The framework is made of two-inch oak and the panel is mounted with wood-screws. (Whenever a screw is sunk in hard oak, drill a hole two sizes smaller than the screw and put some paraffin in the hole; the screw then turns in as easily as in soft wood, but will hold better.) Of course the transmitter may be mounted on a breadboard; although it is well worth the few dollars' difference to have the transmitter and power supply neatly mounted in the frame.

The "Power" Panel

The power panel takes up the entire bottom half of the frame, with the exception of the six-inch legs. The wiring diagram plainly shows all connections and, if it is followed closely, no trouble should be encountered in the construction of the power supply. The 110 volts A.C. enters

through a fuse block (fitted with ten-ampere fuses), and goes directly to the filament and plate switches to the two transformer primaries. The filament transformer has three secondaries, which furnish power for all filaments; while a common plate supply is used for all tubes. The plate transformer secondary delivers six hundred volts each side of center; this is rectified by two '81 tubes in a full-wave circuit.

One of the new mercury vapor 280M tubes has been tried in place of the two '81s, and gave slightly better regulation. It would be advisable to use this new tube from an economical standpoint, also; that is if your filament transformer happens to have a five-volt winding. While only rated at 500 volts, the 280M runs cool with 600 volts on each plate.

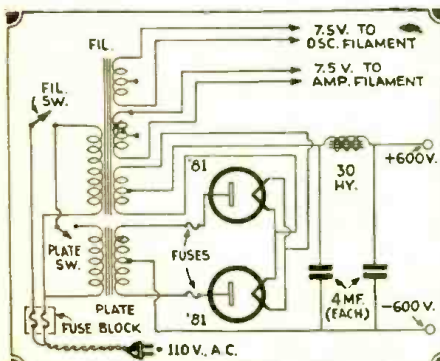

1—Diagram of Mr. Henry's power supply for his short wave transmitter



Side view of Mr. Henry's transmitter.

“HAM” STATION

For Pleasure—and 1932”

Filter Details

The filter consists of a 4-microfarad condenser on either side of a 36-henry choke. Too much stress cannot be laid on choosing good husky filter condensers and chokes. The condensers should have a *working* voltage of 1,000—and that doesn't mean a *test* voltage of 1,000! The filter choke should be one rated at 250 milliamperes and well insulated. A quarter-ampere fuse is inserted in the plate lead of each rectifier tube. (An ordinary flashlight bulb makes an excellent fuse, in case you find it difficult to obtain such low current fuses.)

The Oscillator

The oscillator frequency is controlled by a quartz crystal, whose fundamental falls somewhere between 3,500 and 3,600 kilocycles. If the fourteen-megacycle band is not to be used the crystal may have a frequency between the limits of 3,500 and 4,650. A 48,000-ohm resistor is shunted around the crystal; as this has proved itself superior to “C”-bias. The excitation tap for the first doubler and buffer is taken directly off either end of the coil L1.

The oscillator does not “spill” and is just as stable when the buffer is tuned to the first harmonic, as when the clip is moved towards the filament end of the tank coil. However, should the oscillator spill, merely move the clip towards the center until it is again stable.

If a crystal proves too expensive, simply use an untuned choke plugged into the crystal mounting, and remove the

fixed resistor. A 10,000-ohm resistor is then inserted between the untuned choke and ground. In case this arrangement is used the frequency doublers are omitted; but the oscillator will have to be equipped with plug-in coils and operated on the same frequency as the power amplifier. At W9DFR all coils are of the plug-in type. By means of two crystals, one on 3,533 and the other on 1760 kilocycles, the band-changing problem is simplified. So much for the oscillator.

Frequency Doublers

The two frequency doublers are somewhat similar to the oscillator except for the grid circuit. The radio-frequency choke may be any one of the short-wave receiver type. The biasing battery is 135 volts and may be common for both doublers, along with the power amplifier. The bias on the amplifier is only forty-five volts negative. C4 may be omitted from all stages; but it is best to retain it, in case the choke passes some radio frequency.

The Power Amplifier

Now for the final stage, the *power amplifier*. It is a little giant, even though it uses only two '10 tubes in a push-pull circuit. The switch S1

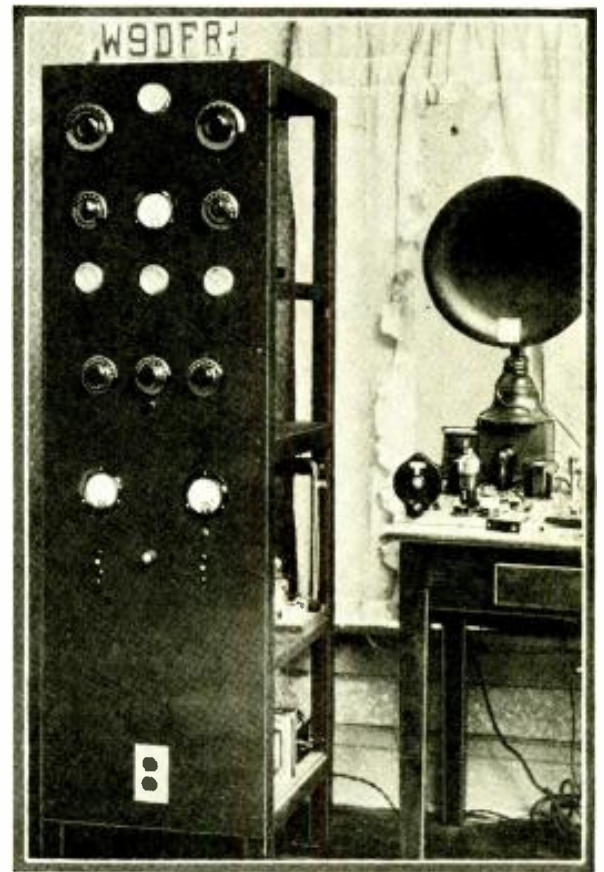

Starting from the top, reading from left to right: Antenna tuning condenser, 0-2.5 ampere R.F. meter, antenna tuning condenser. Second row, 3 plate neutralizing condenser, 0-300 millimeter (plate of P.A. stage), neutralizing condenser. Third row, 0-100 ma. (2nd frequency doubler), 0-100 ma. (1st frequency doubler), 0-100 ma. (crystal oscillator). Fourth row, 2nd doubler tank condenser, 1st doubler tank condenser, oscillator tank condenser. First row on power panel (lower panel), 0-15 AC voltmeter, 0-750 DC voltmeter. Below filament voltmeter is the filament switch which lights all filaments. Below plate voltmeter is plate switch which applies the high voltage to all stages. (On the operating table at the right an AC high-frequency receiver and power amplifier are visible.)

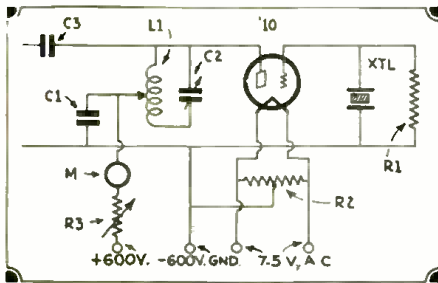

2—Oscillator hook-up: R1—48,000 ohm field resistor; R2—40 ohm center tapped resistor; R3—40 watt clarostat; C1—.001 m.f. variable cond.; C2—.0025 m.f. 1,000 m.f. variable cond.; C3—.0025 m.f. 1,000 m.f. mica cond.; L1—34 turns, No. 22 D.C.C. 1 1/2" dia.

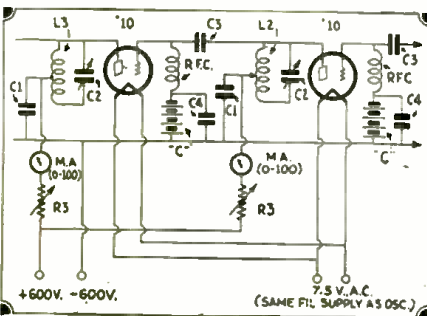

3—Frequency doubler circuit: C4—.001 m.f. 200 volt condenser; L2—20 turns No. 20, on 1 1/2" dia. tube; L3—12 turns No. 20, on 1 1/2" dia. tube.

This transmitter was selected by Mr. F. E. Handy, of A.R.R.L. Headquarters, as one of the sixteen stations in the United States to transmit a standard frequency during the frequency measuring test conducted in October. See page 35 of October QST or page 36 of September QST.

is closed and S2 is thrown so that the center tap of L4 goes to the “C” bias battery when using this stage as an amplifier. If it is desired to use this as a self-controlled oscillator, merely open S1 and reverse S2. In this way you may operate anywhere in the band without buying a flock of crystals.

If the filament by-pass condensers are of the order of one-half to one microfarad, no trouble should be experienced from key clicks. The plate by-pass C1 may be omitted; but this may cause C5 to arc in which case C1 should be retained.

L4 is wound on a tube base of number 20 D.C.C. wire,

and care must be taken to get the exact center. The inductance L5 is made of 3/16-inch copper tubing, mounted on stand-off insulators spaced four and one-half inches apart. The diameter of the coil is two and one-half inches. All copper tubing inductances should be polished and given a coat of clear duco, so that the “skin effect” at high frequencies will not be changed by corrosion.

(Continued on page 349)

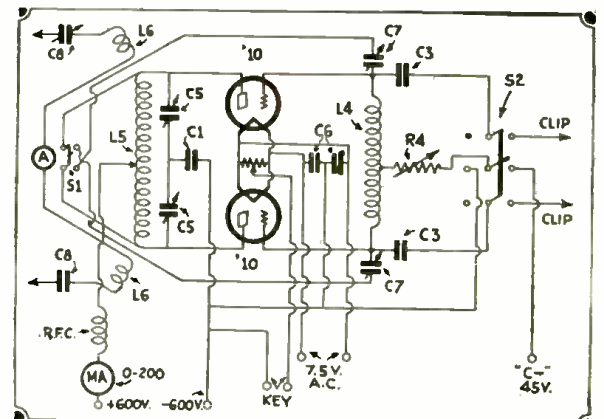

4—Power amplifier circuit: C5—Double section G.R. condenser (0.05 m.f. each section); C6—1 m.f. fl. by-pass cond.; C7—Neutralizing cond. (23 plate mid-pt. double spaced); C8—.00025 m.f. antenna tuning cond.; S1—Double-pole, single-throw switch; S2—Triple-pole, double-throw switch; R4—0-100,000 ohm Bradleyohm.

SLIDERS Do The TRICK

By NELSON G. HAAS

Actual reception was heard on this "slider type" receiver by one of the editors—and strange as it may seem—it appeared to equal anything the "plug-in" coil jobs can do. The "purists" will yell about "losses," etc., but "the proof of the pudding . . ."

tension shafts or knobs; for the less metallic or other materials used in their construction, the better.

In using this type of inductance, it is possible to obtain the proper ratio between the grid and plate inductances for every band; dead spots in the middle of a band being eliminated by a slight change in this ratio.

No trouble has been experienced, since this inductance was designed without complicated switching or other arrangements to take care of the short wave experimenter's old "Bogey Man"—"Dead-end Loss". No loss of signal strength or sensitivity has been experienced upon substituting this unit for the plug-in coils, and the writer is under the impression that this particular fear belongs to the days when everybody was sure that we would require "special tubes" to work below 100 meters, that regeneration controls must have scales or dials, and that antenna current in a transmitter is something that should run around five amperes, if you want to work out-of-town.

Rebuilt Condenser Used

The writer, at this point, feels that it might be of interest to others to describe the re-built tuning condenser used in this receiver. This condenser was rebuilt primarily to prove that it is possible to rebuild a "broadcast" condenser into a good short-wave job. It was found, after

(Continued on page 357)

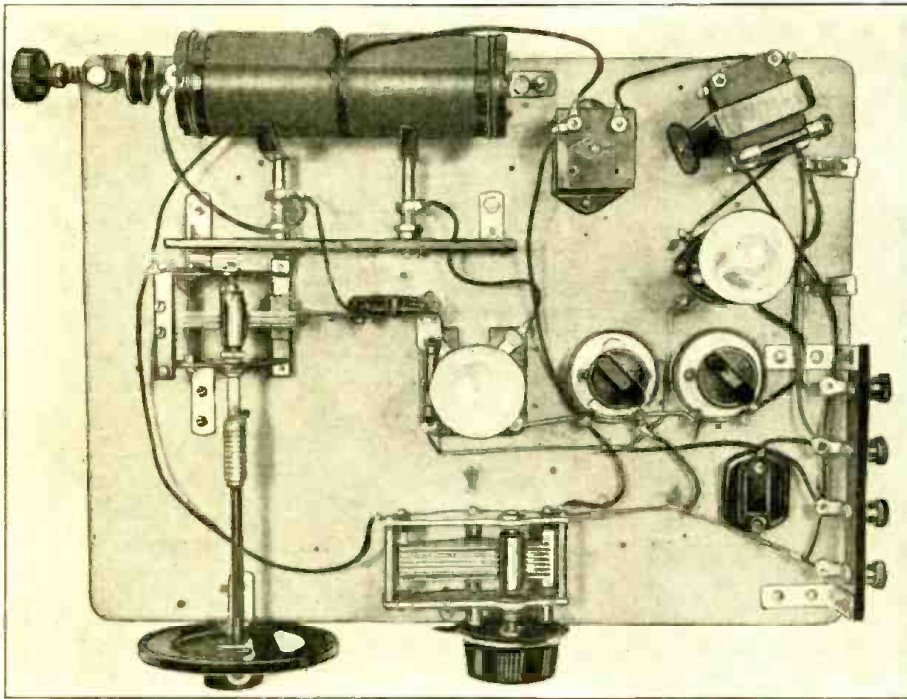

Mr. Haas' neatly arranged short wave receiver. Note "slider" adjusted coils at rear of baseboard.

THE elimination of plug-in inductances from short-wave receiving sets has been the goal of many an experimenter and many weird and unusual types of variable inductances have been devised by the various ones seeking this result. That most of these devices are (more or less) successful is, of course, to be expected; but the majority of them have been entirely too complicated, requiring either too much "machine work" in their construction, or too great a space for their installation in a set. With this in mind, the writer has made an attempt to devise an instrument relatively simple to construct, operate and install in a set.

The present instrument has been designed for and installed in a battery-operated, two-tube short-wave receiver which is unshielded and mounted in "breadboard" fashion, and which formerly used plug-in coils. The change to the new form of inductance was made merely by removing the socket formerly used for the plug-in coils and rewiring that portion of the set to give the necessary clearance between leads.

Winding the Coils

The instrument consists of a threaded bakelite form, two inches in diameter and about five and one-half inches long. (The form used by the writer is composed of two bakelite forms formerly used in broadcast sets; these have been bolted together with very small brass bolts, thus giving a single form of the required length). No. 22 bare copper wire is wound on in two coils of sixty turns each, with a spacing of around 3/8-inch between them, in the center of the form. Care

should be taken to see that the wire is put on under considerable tension, and dead-ended firmly at each end.

The inductance of either coil is varied at will by a rotating blade as shown in the diagrams. The actual construction of these blades and their mountings can best be left to the builder's individual ideas, since the materials available will vary. The fact should be kept in mind, however, that these blades are not used for actual tuning but for the selection of the proper number of turns of each coil required to cover the frequency-band desired. They should exert considerable pressure on the wire at the point of contact, and need not be provided with ex-

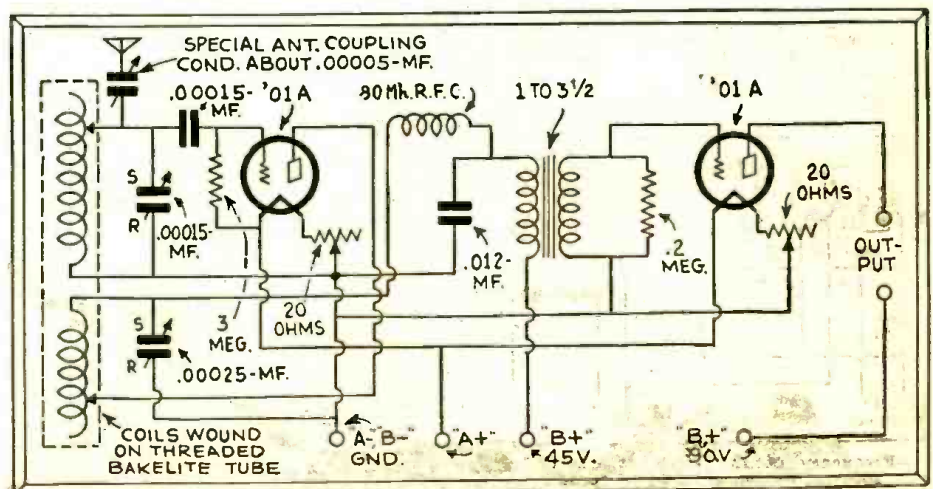

Wiring diagram for "slider type" variable inductance receiver.

Famous English Short Wave Laboratory

THE accompanying photographs show the very interesting short wave research laboratories located at Slough, England. Here considerable research work has been done in tracing thunder-storms, by means of a sensitive radio direction finder, which picks up the disturbances and registers the effects by means of a cathode ray oscillograph. In this way the discharges caused by the light disturbances are filmed, and together with a film record made simultaneously at Leuchars, Scotland, is projected on a huge map of the world, indicating the location of the direction. One of the accompanying pictures shows an engineer making galvanometer measurements on a short wave receiver, and also one of the special electric-pen recorders, with its moving paper chart; note the zigzag record on the chart. The photo below shows one of the elaborate short wave antenna structures at Slough, with a specially designed short wave antenna and measuring instrument in the foreground; one of the engineers has his hand on the adjustment lever.

Photo at top shows engineer making measurements with galvanometer on short wave receiver, in one of the laboratories at Slough, England. Note electric pen recorder at right of photo.

Photo at right shows elaborate short wave transmitting antenna system, with main transmitter located in insulated house built on platform in background. Measuring aerial and instrument is seen in foreground.

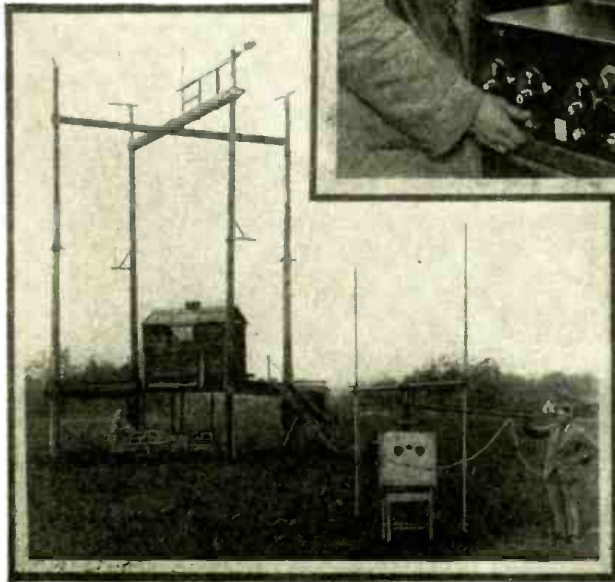
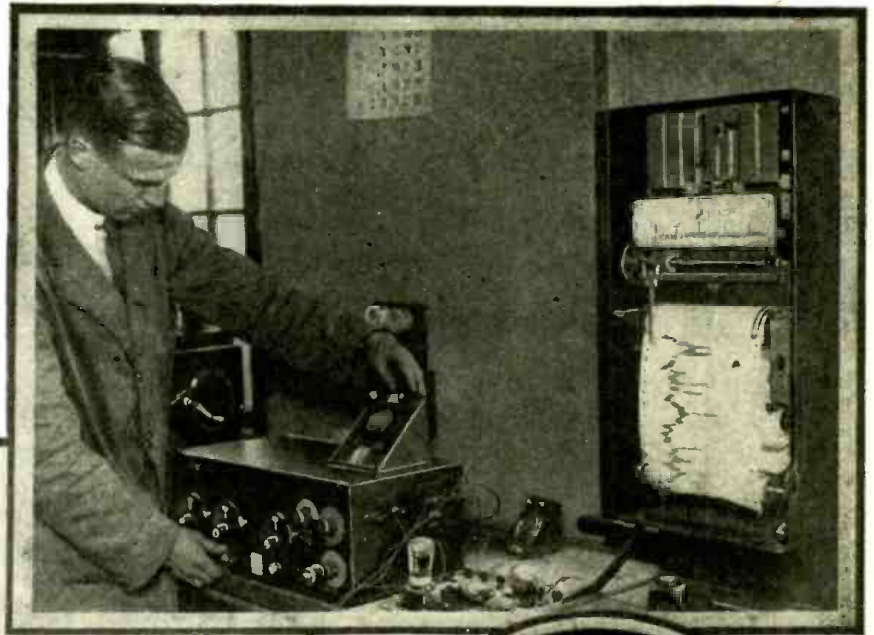

Close-up of operator measuring signal strength of five meter waves, with apparatus mounted in automobile laboratory.

English Police Adopt Short Waves



IF America does not watch out, they will find their police systems outdistanced by the European police radio-nets. Short waves are being adopted rapidly, both for police and fire departments, in leading cities everywhere today. One of the latest applications of short waves is in the equipment of portable transmitters and receivers, which are to be installed in the automobiles used by the state police. In this way time can be saved and traffic jams quickly cleared; thanks to short waves, which will place the chief of the police or fire department in constant and instant touch with his squads, who may be many miles away from headquarters in fast moving automobiles. Tomorrow, every large city will have an elaborate short wave network for both its police and fire departments. Airplanes will form a part of these systems shortly. When planes become a part of our police systems, short waves will be invaluable.

Left: English police operator at short wave transmitter receiving an important hurry call. Note "mike" for voice transmission.

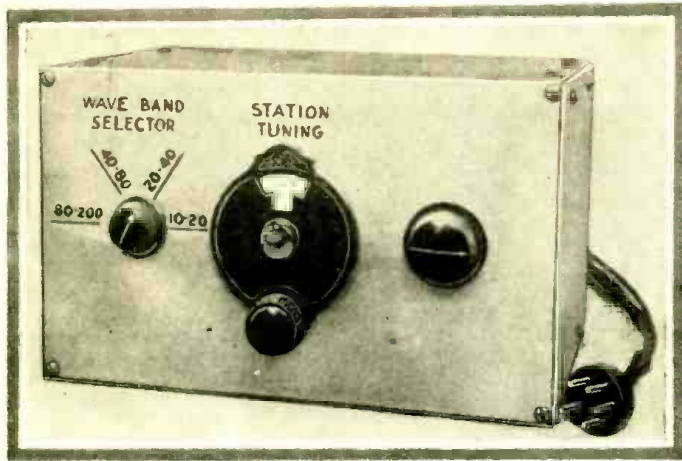

Handsome appearance of the short wave converter especially built at the editor's direction and incorporating the new "Best" short wave "band" coil and switch unit, which eliminates plug-in coils. Range 10 to 200 meters.

The "BEST" SHORT WAVE CONVERTER with Complete Constructional Data By H. WINFIELD SECOR

Short Wave "Fans" the world over, have been looking for a band coil and switch assembly unit, which they could buy and then build a set or converter around—here it is. A complete converter is described using this new switch-coil unit, also data for building a short wave "receiver".

THE piece of apparatus, for which every short-wave fan has been looking, is at last available in the radio market; it comprises nothing less than a complete set of coils with switches, all assembled and wired, by means of which one can easily build a first-rate short-wave converter without "plug-in" coils. The front cover of this magazine, as well as the accompanying photographs, illustrates how the converter may be efficiently and beautifully built in an aluminum shield box.

The wavebands covered by the Best short-wave coil and switch unit are 10-20, 20-40, 40-80 and 80-200 meters.

The coil and switch assembly, comprising the four sets of coils wound accurately on bakelite tubes, includes an es-cutechon plate with the wavelength band values engraved on it. In the apparatus built for and tested by the editors, and here illustrated, the four positions of the coil switch were marked on the front aluminum panel of the shield box. The converter as here built up was specially constructed by the York Engineering Co., after the plans perfected by the Best engineers, who conceived the idea of supplying our short-wave fraternity with the coil-and-switch assembly here shown.

This short-wave converter, which is of the super/het type, will bring in short-wave stations on any broadcast receiver. The converter has been tested out on several T.R.F. as well as several makes of superheterodyne broadcast receivers.

In hooking up the converter to a T.R.F. broadcast receiver, the five-prong

plug is inserted in the first R.F. socket on the broadcast set, the tube being removed for the purpose. The regular antenna is connected to the aerial post on the converter; while a ground wire from the metal chassis is connected to the ground post on the broadcast set; and to this post the usual ground wire is left connected.

In using this converter in conjunction with a superhet broadcast receiver, the five-prong plug is inserted in the R.F. socket ahead of the first detector; in tests on other superhets which do not

being removed for the purpose.

This converter employs only two tubes, a '27 for the oscillator and a '24 for the detector. It will be seen that the plate and heater supply for the two tubes in the converter is obtained from the power-supply unit in the broadcast set, through the medium of the five-prong plug. Very little drop in voltage was registered when using this converter with the average broadcast receiver; but, if the converter must be used with a cheaply-built receiver, which has no surplus power in the heater and plate-supply unit, a separate source of "B" supply can be used for the converter—or even "B" batteries, for that matter.

One of the accompanying drawings gives the winding data for the four coils used to cover the various short-wave bands from 10 to 200 meters. Bakelite tubing (1¼ and ¾ inches diameter and 4½ inches long) is used to wind the coils on, in the manufactured unit. If you can obtain no bakelite, the coils may be wound in the manner illustrated, on wooden rods previously boiled in paraf-

Anyone with slight mechanical experience can easily assemble this short wave converter, following the simple diagrams given herewith.

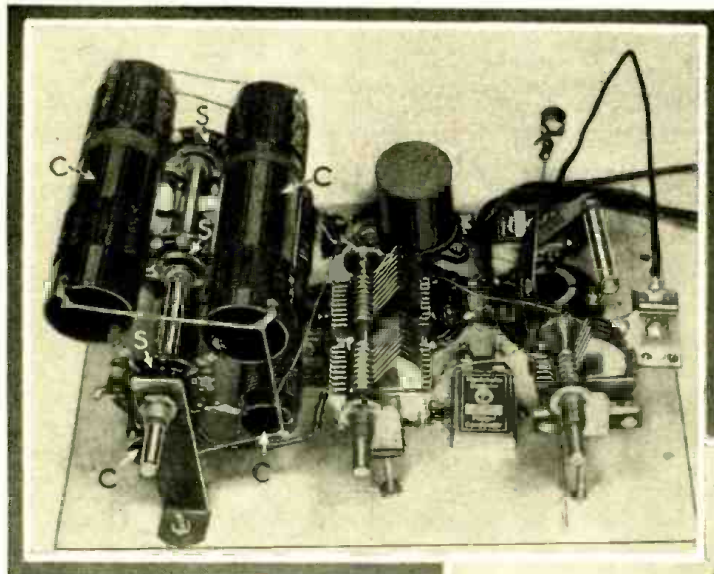

Right—Close-up of the "Best" short wave converter "coil and switch" assembly, the four sets of coils being marked "C". The clip goes on the cap of the S.G. tube.

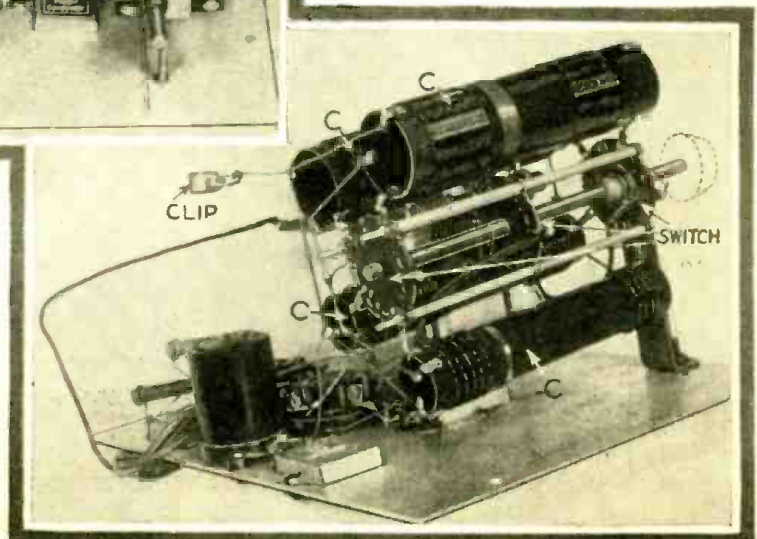

contain a n R.F. stage ahead of the first detector, the plug was inserted in the first detector's socket, the tube in either case

fin; or on cardboard tubes of the diameter specified, soaking the tubes in hot paraffin before using. If you do not have the exact size of wire, there will be but slight change in wavelength, if you use wire one or two sizes different from that called for. It goes without saying, that all joints in wiring up the converter should be thoroughly soldered with a non-corrosive flux.

Looking at the tuning arrangement, we note that a Hammarlund two-gang midget condenser, each unit of 140 mmf., serves to tune in the station; one unit tunes the aerial inductance, and the other the plate coil of the oscillator. The grid coil of the oscillator is not tuned. A second 80-mmf. midget condenser, having a separate knob of its own at the right of the panel, acts as a vernier to finish up the fine tuning.

In operating the converter, one first turns the band-selector switch knob to the desired wavelength band; next, the two-gang condenser vernier is slowly dialed until the station is heard. The third knob controlling the vernier condenser is adjusted last.

Making a Short Wave "Receiver"

Some of our readers would undoubtedly like to use this switch-and-coil idea for a short-wave receiver, instead of a converter; and one of the accompanying drawings contains the coil data and wiring details for such a receiver. The diagram shows how to connect a pair of phones to the short-wave receiver, if you want to use only one tube; and also how you may connect the primary "P" of the first audio transformer (of a two-stage amplifier) in place of the phones, at the points marked X and X-1.

In constructing either the converter or the receiver, note

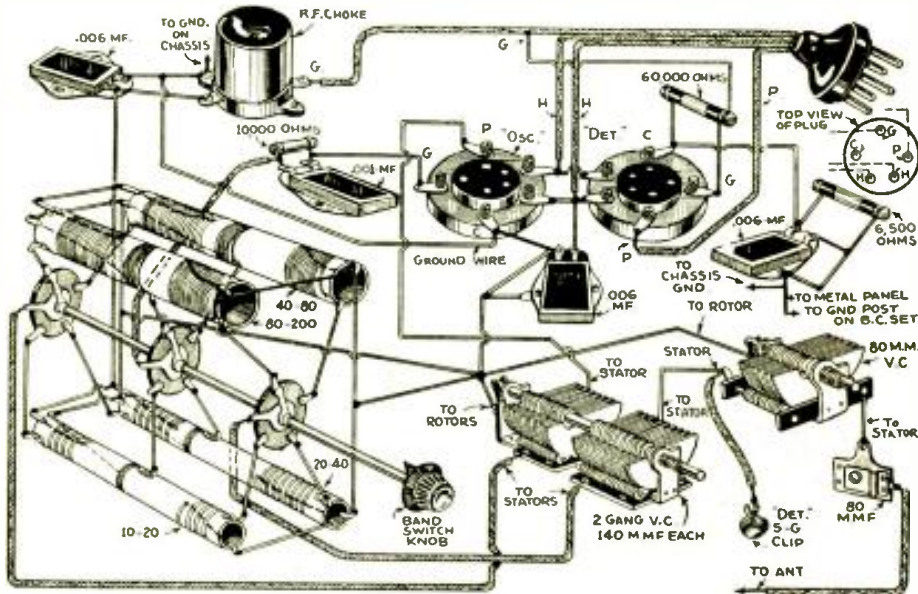
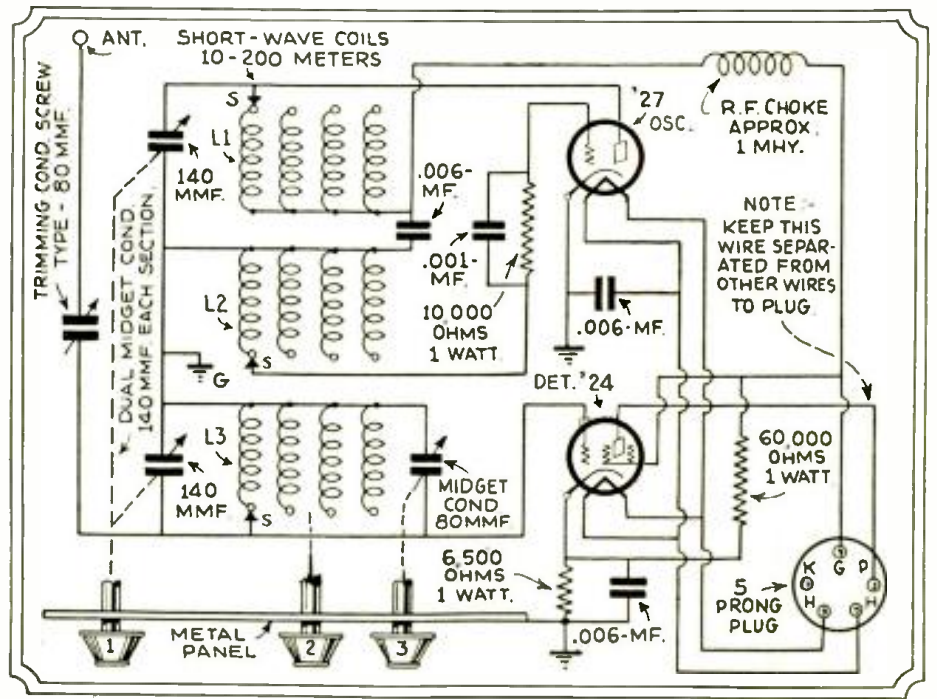

Above — Schematic wiring diagram for building the short wave converter, which will bring in the short waves when the five prong plug of the converter is inserted in the place of the first T.R.F. tube of your broadcast receiver. When used with a broadcast "superhet" receiver, the plug is placed in the R.F. socket ahead of the first detector, or else in the first detector socket, the tube in either case being removed for the purpose.

Left — Picture diagram for constructing the short wave converter here described, which can be easily put together even by the novice who has had no experience in building a set. The complete list of parts necessary for building the converter are given in the article.

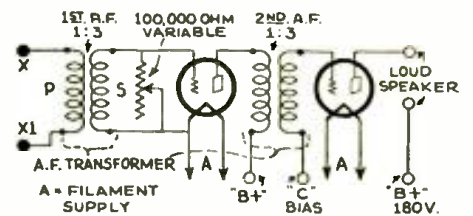
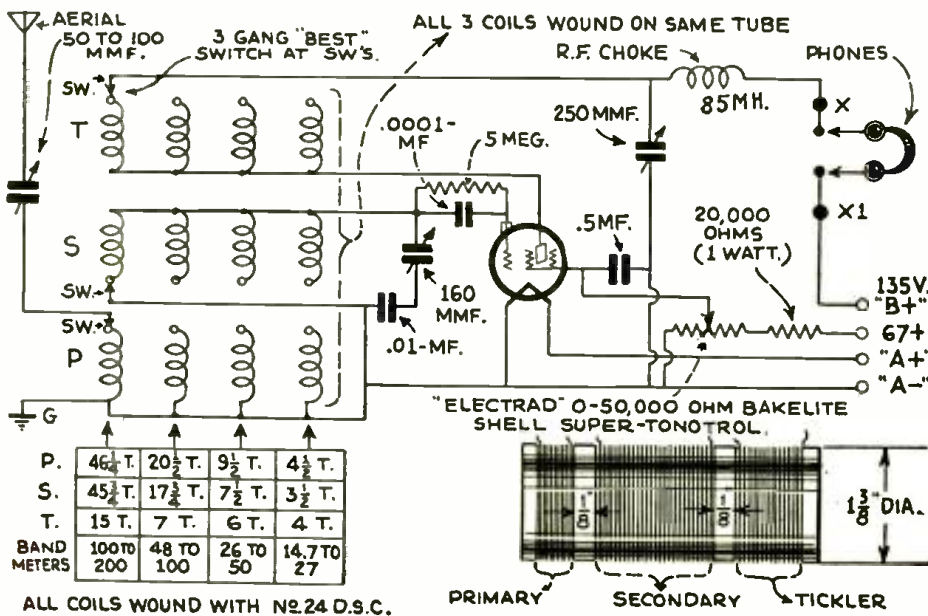

A complete "receiving set" may be built instead of a converter, using the switch principle; at the left coil data is given for building such a receiver. Above is given a two-stage audio amplifier, which will put the signals on a loud speaker.

the series antenna condenser, may have a capacity of anywhere from 50 to 100 mmf. This condenser may be of the Hammarlund equalizer type, and is adjusted but once for each antenna. Many short-wave operators prefer to mount this condenser on the front panel of their set; as it affords the best means of re-

(Continued on page 366)

S - W SETS *at the*

BERLIN RADIO EXPOSITION

By DR. FRITZ NOACK

The European designers have some interesting ideas, which are brought out in the short-wave apparatus here described and illustrated. One of the outstanding features of foreign radio apparatus, particularly German-built, is the fine workmanship and quality of the parts used, which is exemplified by the converter and receiver here shown. The moral is— if you want "good" results—use high quality parts and don't scramble your wiring.

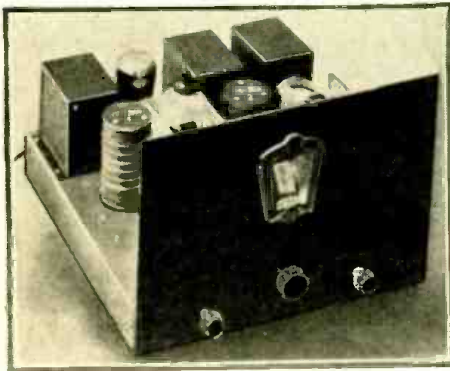

A German short wave converter, made by Schackow, Leder & Co. (trade-mark—"Schaleco"). It's of super-het type.

IN Germany short-wave reception has not become so common as in the United States; consequently there are at present extremely few short-wave receiving sets in everyday use by the general public.

It is a different thing for the radio amateur. To be sure, there are only a few firms in Germany making short-wave sets or kits for home construction, but these firms are extraordinarily efficient and furnish only good sets.

Of ready-made receivers we know at present, in Germany, only the Telefunken short-wave receiver; a simple regenerative receiver (design by Seibt) and a radio receiver built under the name of Lumophon for regular radio waves, which at the same time makes short-wave reception possible. The last-named set has a screen-grid radio-frequency tube, detector, and a two stage audio-frequency amplifier. In this set the antenna is connected with the ground through a resistance, coupled to the grid of the aperiodic R.F. amplifier.

This set is similar to the Schackow, Leder & Co. "All-DX" set, for amateur assembly, which varies from the Lumophon set, in having the grid circuit tuned. The two tuning circuits of the "All-DX" are operated at the same time by a common shaft and dial. Two trimmers make possible finer adjustment of the two tuned circuits. It is noteworthy that the set can be used for either battery or A.C. operation. Figs. 1 and 2 show this set inside and out; while Figs. 3 and 4 show the circuit.

Short-Wave Converter Shown

To permit using an ordinary radio receiver for short waves, the same firm

has furthermore recently built a supplementary apparatus (converter), consisting of a detector tube with a separate oscillator tube. This also is arranged for either battery or A.C. operation. The converter acts as a frequency changer (super). A noteworthy point is the careful arrangement of the heater leads, as well as the grid leads, and in particular the wide range of use. It is so arranged that one can receive either phone, CW or ICW. One would be able



The Schaleco "All-DX" S-W receiver with cabinet.

to obtain this result in a well-known way, by switching on the regeneration when receiving CW telegraphic stations with the regular radio receiver, and by switching it off when receiving telephone or ICW telegraphic stations.

To avoid this inconvenience, the oscillator of the new converter provides a special arrangement to switch in a supplementary regenerator which, besides the short-wave oscillation, produces another of higher wavelength. In receiving ICW code, the oscillator is accordingly given an additional modulation. The switching is accomplished very simply in the converter, with nothing to be changed in the radio receiver itself.

This converter is therefore very noteworthy, and makes possible extremely loud short-wave reception. The oscillator is so adjusted that an intermediate frequency of about 375 to 500 kc. (600 to 800 meters wavelength) is attained; to which wave the radio receiver is to be tuned.

If one wishes to connect the converter to a broadcast receiver using a high antenna, or indoor antenna, then the terminal "Radio-App." of the converter is to be connected to the antenna post of the receiver. If the converter is to be used with any receiver equipped for normal operation with a loop antenna, then, instead of the latter, a coil of 75 turns is to be put in. The terminal "Radio-App." of the converter, is to be connected with that terminal of the receiver which leads to the grid of the first tube. One obtains the greatest power with the radio receiver set for approximately 500 meters, by adjusting the receiver's regeneration to just under the point of oscillation. The radio receiver ought to

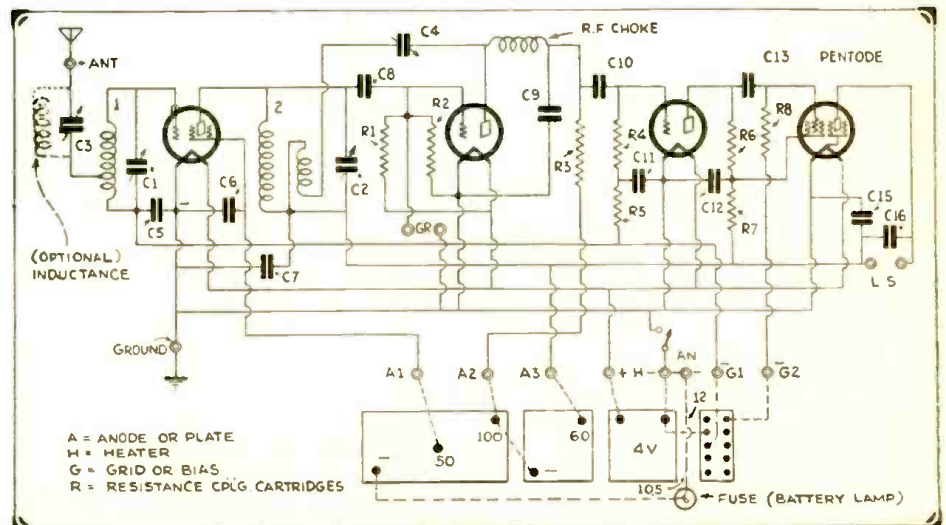

Hook-up of the "All-DX" (German) S-W receiver, having tuned R.F. stage ahead of regenerative detector, with resistance-coupled audio stages; pentode output tube. Shown here for battery operation.

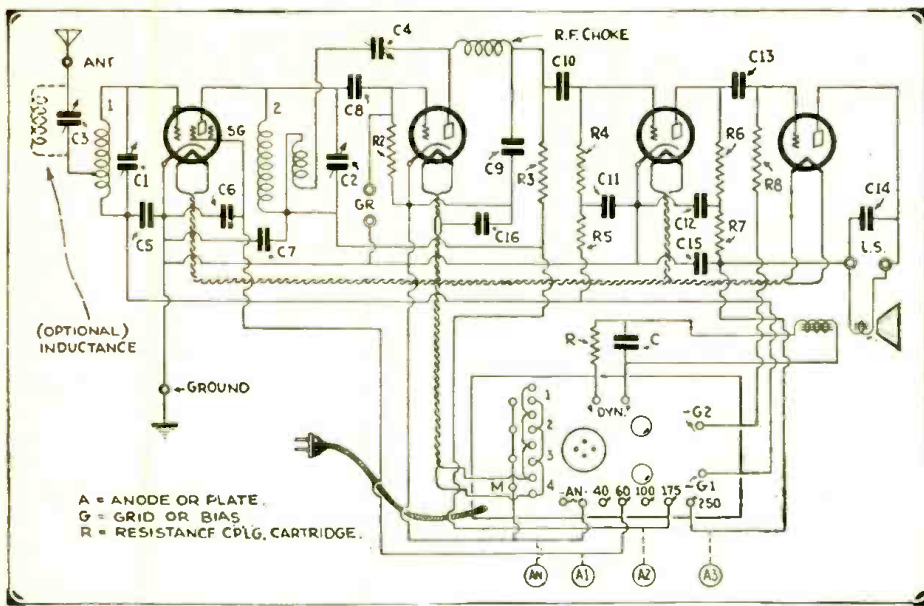

remain fixed. The little trimming equalizing condensers placed on C1 and C2, are at present to be set for about half their range of variation by means of the adjusting screwdriver. The switch is to be set at "Telegraphic." If this is properly done, one notes the fact through the weak sound from the transformer T-Tr when regeneration condenser C-4 is turned in. The two tuning condensers C1 and C2, whose shafts are connected together, are now turned by the right hand, while C3 is at the same time turned by the left hand; so that the tuning sound is always heard. C3 must always be operated. When one has once found such a telegraphic station, then the trimmers placed at C1 and C2 must be further adjusted; so that all transmitters appearing between 20 degrees and 90 degrees on the dial of condensers C1 and C2 can always be tuned afterward by condenser C3.

For receiving C.W. transmitters the oscillator switch is to be set at "Telegraphic"; for receiving modulated transmitters, at "Telephonic."

The "All-DX" S-W receiver again—arranged here for 110-volt A.C. operation. "GR" represents phonograph pick-up terminals, connected between grid of detector and ground. The tuned inductances and condensers across them would be the same as for American sets, coil data on which appears in this and other issues of SHORT WAVE CRAFT.

Photo (right) shows interior view of "All-DX" S-W receiver. At left—screen grid tube; next—detector tube; at right—audio frequency tubes.

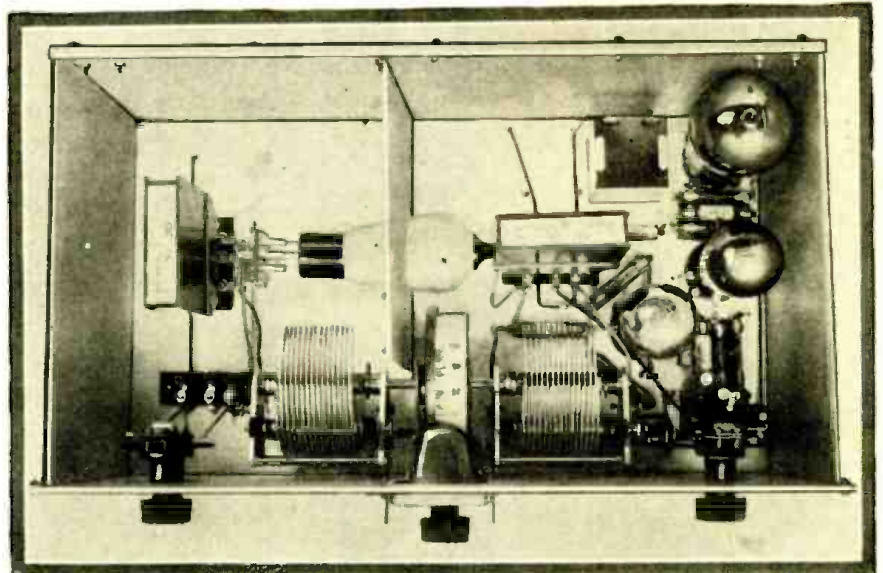

have at least one screen-grid tube, or two ordinary radio-frequency amplifier tubes, of the neutrodyne type.

Adjusting the Oscillator

Adjusting the oscillator is done as follows: Set the switch at "Telegraphic," then turn the regeneration condenser C4 so far to the right that, on holding the ear near the transformer T-Tr, a weak whistle is heard. Condenser C4 needs to be set only once, and can ever after

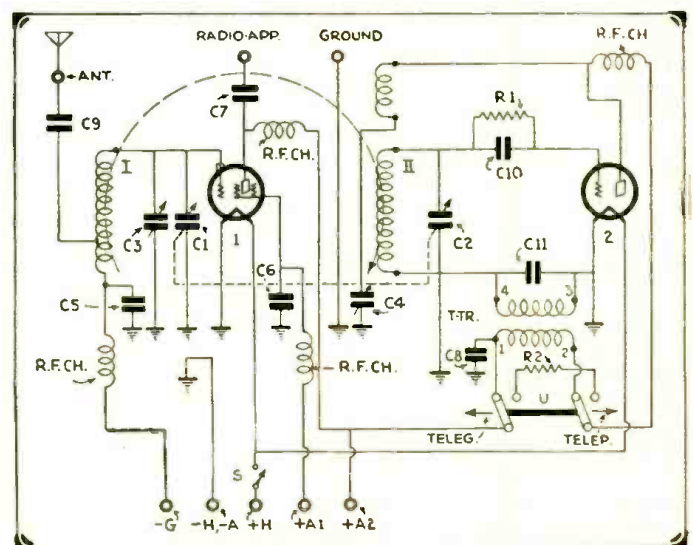
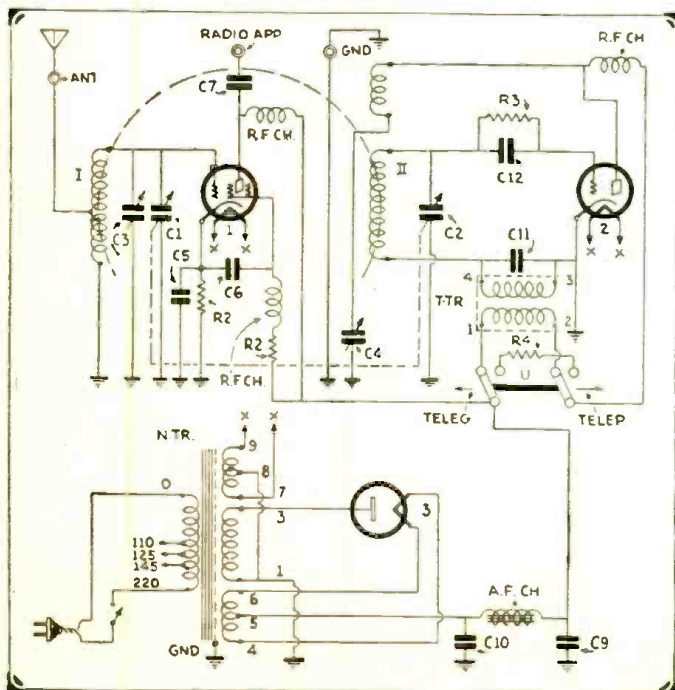

Above: Battery hook-up of German super-het converter. The terminal "Radio-app." is connected to the antenna post of the "broadest" set. C5, C6, 5 mf. condensers; T-Tr A.F. choke; C9 and C10, .00025-mf.; C7 and C8, 1-mf.; R1, 2 megohm; R2, 15,000 ohms. Left: A.C. operated S-W converter. Tuning coils and capacities same as for American practice. T-Tr, A.F. choke; C5, C6, 5-mf.; C7, 1-mf.; C9, C10, 2-mf.; C11, .002-mf.; C12, .00025-mf.; R2 (left) 3,000 ohms; R2, 60,000 ohms; R3, 2 meg.; R4, 20,000 ohms.

QUASI - OPTICAL SHORT WAVES

Electron Oscillations

By C. H. W. NASON

What is the wavelength of a '99 tube? What is the basic action occurring in an electron oscillator? What conditions or factors govern the frequency of such an oscillator? How are the signals from such an oscillator received?

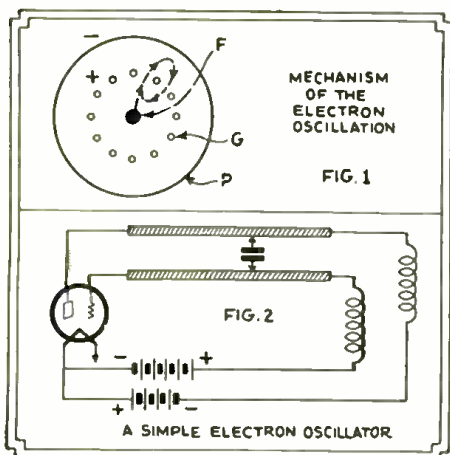

Fig. 1 shows path of an electron between filament and negatively charged plate in an electron oscillator. Fig. 2—Hook-up of simple "electron oscillator."

THE waves from 10 meters down to 5 centimeters are often referred to as the "Quasi-Optical range." (The inference may be gleaned from the dictionary they are "near-light" waves.) These waves may be treated in many cases as light waves—particularly in the shorter ranges, where they may be reflected from metallic bodies having either plane surfaces or specific curvatures for directive transmission or reception. The waves have been acted upon by lenses made from dielectric materials (bakelite for example) in such a manner as to demonstrate the fact that they closely resemble in behavior light waves, more usually thought of under the classification of "Optical."

By means of special circuits, devised for the utmost of simplicity and efficiency, the normal vacuum-tube oscillator may be employed with good effect at wavelengths as low as 1 meter! Below this the stray tube and circuit capacitances are much in evidence, and the classical circuits are rather hopeless. In the lower range—speaking now in terms of wavelengths rather than frequencies, to simplify matters—the "electron oscillations" of Barkhausen and Kurz, and of Gill and Morrell, are most effective. Although these oscillations are known to the physicist, very little may be found regarding them in standard works on radio. It is necessary, therefore, that we first consider the mechanics of these oscillations, before entering into a more detailed exposition.

The Mechanism of the Electron Oscillation

Before going further, it is well to state that the most satisfactory tubes for use in these oscillators are those having concentric elements—cylindrical plates, etc. These are the '99, the '27, the '52 (more ambitious, of course) and certain of the tubes provided the government by various organizations during the war. Karpus in the *General Radio Experimenter* for May, 1931, indicates success with the G.E. "CG-1162" which is available from many radio salvage organizations. Electron oscillations may be obtained with other tubes specially developed for the service but, quite naturally, our interest rests with those tubes available for experiment.

With the electron oscillators, the determination of frequency no longer rests upon the inductance and capacitance

values of a tuned circuit, but rather on the electrostatic forces acting upon the individual electrons given off by the filament, and the resultant time element. Fig. 1 indicates the inter-electrode spacing of a triode (3-element tube) of the usual character. Note that the grid is positive and the plate negative, with respect to the filament. An electron, leav-

tions—barring factors too complex for inclusion in our discussion—is as follows:

$$\text{Wavelength (in Centimeters)} = \frac{1000 d}{\sqrt{E}}$$

where "d" is the distance between electrodes and "E" the voltage. (The equation is for the original two-element tube of Barkhausen and Kurz, and not for a triode.)

The Barkhausen oscillations are independent of the circuit constants, to all intents and purposes.

Circuits for Producing Electron Oscillations

Fig. 2 shows the circuit arrangement of an oscillator for producing the Barkhausen effect. The Gill-Morrell oscillations are true electron oscillations, but their frequency is determined by the distance "d" between the elements and the short-circuiting condenser "C." The change between the two types of oscillations may be effected at will by altering the circuit conditions. In the Gill-Morrell effect, the oscillation is due to the timing of the electron's orbits by the oscillating circuit formed by the Lecher wires. The Gill-Morrell oscillations are much stronger and are preferable to the simple Barkhausen type. The transition may readily be obtained by setting the dis-

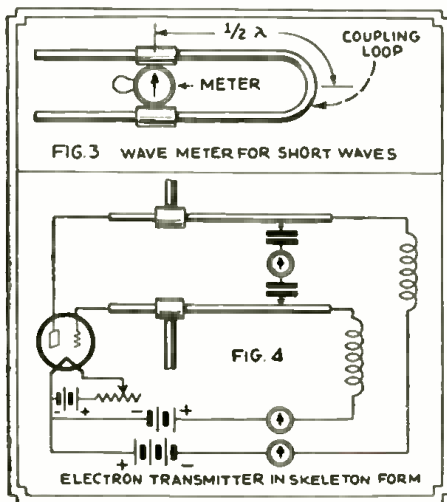

Fig. 3—How to construct ultra-short wavemeter. Fig. 4—Schematic diagram of an electron oscillator.

ing the filament or cathode, is accelerated toward the grid by virtue of the grid's positive potential. The majority of these accelerated electrons will pass through the grid's mesh and, by virtue of their momentum, will travel onward toward the plate until they reach a point where the negative charge on the plate is sufficiently effective to halt their flight: they will then assume a backward path, toward the grid. They rejoin then the other electrons passing toward the grid, following a path somewhat as indicated in the figure. The length of the path taken and the initial acceleration are the criteria for determining the frequency of the cycle. The actual A.C. voltages, making up the oscillatory energy-cycle, are induced by changes in the grid and plate charges created by the moving electrons.

The original formula of Barkhausen covering the wavelength of the oscilla-

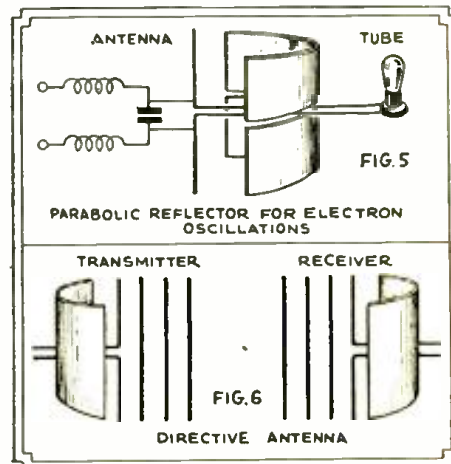

Fig. 5—Shows antenna placed in focus of a parabolic reflector. Fig. 6—Arrangement of directive aeriels with reflectors.

tance equal to one-half the desired wavelength, and adjusting the voltages for the maximum oscillation. The Lecher wires should be calibrated directly in centimeters to check the wavelength—remembering of course that the accuracy is not great. Fig. 3 shows a "trombone" wavemeter for rough measurement of the emitted wave; this is useful in determining the transition point between the two effects. By replacing the milliammeter with a crystal detector and phones, the device may be used to monitor modulated signals.

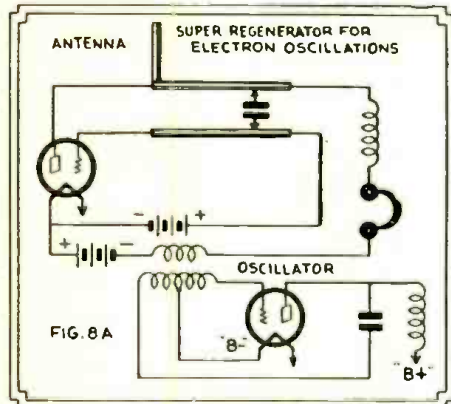

Fig. 8-A—How apparatus is connected to make a super-regenerator "receiver" for electron oscillations.

Electron Transmitters

In Fig. 4 there is illustrated a more complex arrangement of the original figure, showing the oscillator circuit. To this, it will be seen, there has been added an antenna; this should be positioned exactly one-fourth of a wavelength away from the bridging condenser. This places the antenna approximately in the center of the Lecher wire, where the Gill-Morrell oscillations are used, and at an indeterminate distance, depending upon the wavelength of the oscillations generated. The antenna is formed by two copper or brass rods clamped to the Lecher wires by a movable slide. They should be 1/4-wavelength long, and might be "tromboned" for ready variation.

The grid-current meter should be of the order of 0-100 milliamperes while a 0-1-ma. meter may be used in the plate circuit. The oscillatory current may be measured by a 100-ma. thermal milliammeter; the condensers are .001-mf. mica units. The R.F. chokes are simply wound from annunciator wire on a broom handle, and slid off. They are somewhat like the pretty curlicues that we used to employ to connect up buzzers and what not, before we had "wireless" to play with. In tuning the transmitter, the maximum oscillation is indicated by a maximum reading of the plate milliammeter.

The antenna may be backed by a parabolic reflector of the type shown in Fig. 5, with the antenna situated at the focal point. (See the preceding issue of SHORT WAVE CRAFT—page 254, Dec.-Jan., for details of a parabolic curve.) Other types of directive antennas may be employed by the "ham" desirous of going deeply into the operation of the system. A reference to the article by Yagi, in the June, 1928, *I. R. E. Proceedings* will yield much data on the use of directive antennas at such short wavelengths. The directive effect of the reflector may be greatly increased by employing an ar-

range such as that indicated in Fig. 6, at both transmitter and receiver; the rods used in the *director chain* are 1/2-wavelength long, and spaced 1/4-wavelength apart. The metallic reflector may be replaced by a system of five 1/2-wave length rods arranged in a parabola, at the focus of which the antenna is placed.

Receivers for Electron Oscillations

Because of the relatively low frequency stability obtained, little success will be achieved with electron oscillators for communications where straight C.W. is employed; although with A.C. on the filament, the hum modulation will be so great as to alter these conditions by creating an interrupted continuous-wave effect. Receivers for intramural (laboratory reception) work may be quite simple—as shown in the two circuits shown in Fig. 7. It is also possible to achieve high sensitivity in the receiver system by means of the "super-regenerator." Such a circuit arrangement is shown in Fig. 8-a.

The most practical arrangement is that of employing another electron oscillator, almost identical with that employed as a transmitter. Indeed, a "change-over," of such type that a single oscillator may be used for both transmission and reception, may readily be effected.

The most logical arrangement is that shown in Fig. 8-b, where the circuit constants are clearly indicated. The antenna is approximately 1/4-wavelength in

shown in the receiver schematic. It is not necessary to provide a speech amplifier, although it is best to do so where long-range operation is desired. It should be remembered that a variation in the plate voltage of the oscillator effects a frequency change rather than—or as

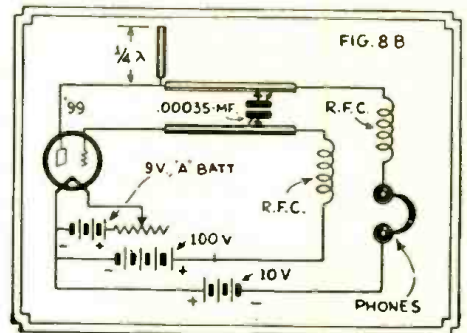

Fig. 8-B—Receiving circuit for electron oscillator signals (wave lengths such as 15 inches).

well as—an amplitude change. The modulation achieved is not so perfect, therefore, as in the case of the usual oscillators. Telephone communication has been achieved up to distances of about twenty miles with "electron transmitters," and telegraphic communication is possible over much greater distances. When we consider the fact that all possible forms of modulation involve a frequency shift, it is surprising that good quality can be obtained. Nevertheless, the quality of speech is quite good.

Tubes and Voltages to Be Used

The following table gives some idea of the voltages to be applied for various tubes and the oscillation wavelength to be expected. All tubes of a given class do not function as electron oscillators and many tubes must be operated with trick filament potentials. With the '27 the filament voltage should be rather low; whereas, in the case of the '99, best results seem to be obtained when the filament is completely deactivated and operated at a high voltage. The grid current is high in all cases, and the frequency range may be limited by the voltage which can be applied without melting the grid—or by the effects of grid emission.

In Next Issue!
more
'HOW TO BUILD'
articles—with data on coils, condensers, resistors, etc., including latest ultra-short-wave apparatus.

Tube	Grid Volts	Plate Volts
'99	90-100	-10
CG 1162	90-200	-1.5 to -15
'27	90-200	- 1 to -15

Wavelength
45.50 cms. (17.7 to 19.6 inches)
40 to 75 cms. (15.7 to 29.5 inches)
40 to 75 cms. (15.7 to 29.5 inches)

The best tube to be used in the receiver is perhaps the '99, because of the extreme portability obtainable.

'Phone Modulation With the Electron Oscillator

Telephonic modulation of the electron transmitter is achieved in the plate circuit, by substituting a modulation or microphone transformer for the phones

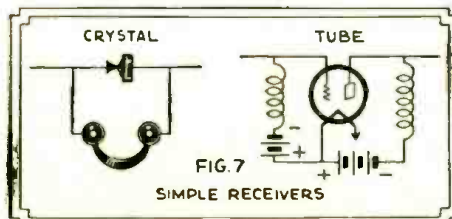

Fig. 7—Receivers for laboratory work may be quite simple, as shown in diagram above.

Constructional Hints
The whole outfit may be laid out on a breadboard, with Lecher wires about one meter (39.37 inches) long, made from heavy copper rod, mounted on G.R. stand-off insulators. Copper clamps spaced with bakelite strips may be used to provide *riders* for the short-circuiting meter, or condensers, so that they may be readily slid along the Lecher wires. The plate and grid voltages should be made continuously variable by the use of potentiometers, and the necessary meters should be provided for taking readings.

All work with electron oscillations is of a highly experimental nature, and no specific data can be provided with a sure-fire operation guaranteed. The experimenter undertaking this work should have had considerable experience with radio equipment, if any hope of success is to be held out to him; it is no game for the tyro.

SHORT WAVE KINKS

for
the *Experimenter*

By "BOB" HERTZBERG

OLD tube bases make very convenient plug-in forms for short-wave receivers of all types; and these are widely used because they cost nothing and fit standard sockets. However, in winding coils for experimental work, it is a nuisance to thread the wire through the tiny holes in the pins and then to file off the lumps

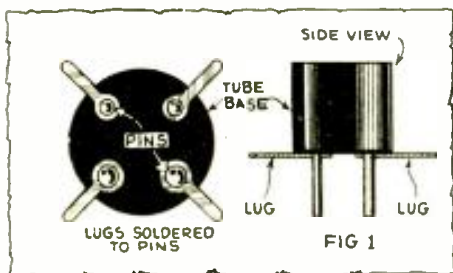

Improved "tube base" coil forms can easily be made as shown.

of solder so that the tips will not get caught in the socket springs.

It is a very good idea to cut up connecting lugs out of sheet copper or brass, and then solder these over the pins, flush against the bottom. (See Fig. 1.) The lugs should be long enough to protrude beyond the sides of the tube base. The ends of the coil windings can then be twisted quickly and easily around the lugs, and considerable time will be saved.

Eliminating "Local" Interference

In some locations, unshielded short-wave receivers (and even shielded ones) pick up the signals from a local or nearby broadcast station, regardless of the tuning adjustment of the dials. This interference is annoying because it is likely to drown out weak foreign stations.

Here is where the good old-fashioned "wave-trap" comes in very handy. A simple but effective trap can be made with any .00035- or .0005-mf. variable condenser and an R.F. coupler consisting of a 15-turn primary and a 55- or 60-turn secondary wound on a one-inch tube. The wire may be No. 24, 26 or 28; cotton, silk- or enamel-covered. The windings should be separated about 1/4-inch. The connections are shown in Fig. 2. Both coil and condenser should be enclosed in a small metal container, for the sake of shielding. An old cocoa or coffee can serves the purpose very nicely.

Comfort in Operating

Physical comfort on the part of the operator is an important feature of successful short-wave reception. The re-

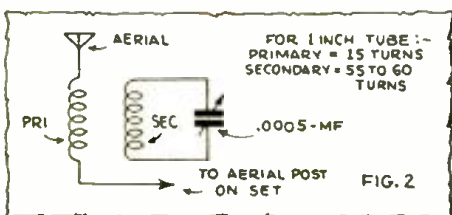

How to build a "wave trap" to cut out powerful "locals".

ceiver should be set back on the table, so that you can rest your arms up to the elbows. Sit on a chair with a fairly straight back, so that your own back will have support. Get your knees well under the table, and relax all your muscles.

Turn out all bright lights in the room. Illuminate the set by a small table lamp, with the shade adjusted to keep the light out of your eyes. (See Fig. 3.) A 15-watt lamp is plenty. Darkness or semi-darkness definitely tends to sharpen the sense of hearing. Often the dial light is sufficient illumination.

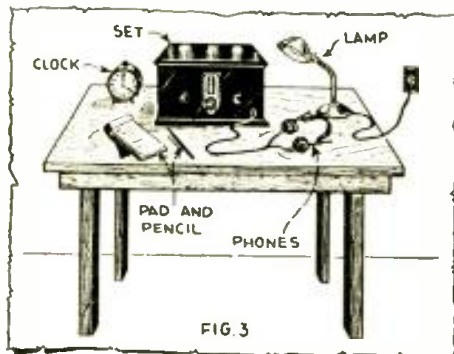

Efficient arrangement of short wave receiver, clock, light and note book.

Keep a clock, a pencil and a pad or notebook within easy reach. Don't rely on your memory, but jot down all dial readings, call letters, time of reception, announcements, etc. This record is very

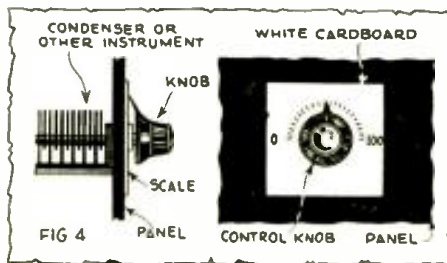

A white paper or Bristol board scale mounted on panel with rubber cement is often a great boon.

useful when you look for the same stations another time.

A Simple Indicating Scale

Many small control devices on a set are not important or critical enough to deserve a regular vernier indicating dial, but do require a scale of some kind on the front panel. Engraving on aluminum or bakelite is expensive. A simple and useful scale can be made of white bristol board (smooth, heavy cardboard), attached to the panel with rubber cement.

Smear cement on both the panel and the back of the cardboard; allow them both to dry to the point of tackiness; and then put the scale in place. Rubber cement is the only adhesive that will really stick smoothly and without wrinkling in a case of this kind. (Fig. 4.)

Notations can be made on the scale in pencil or ink, and can be erased or altered at will. A scale like this is particularly useful on rheostats, padding or loading condensers, band-covering con-

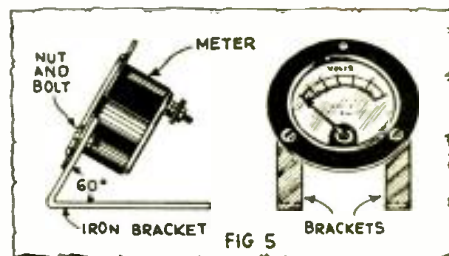

"Here's how" to support that portable meter at any desired angle.

densers, etc., which must be set to a definite spot but which are not manipulated continually.

A Simple Meter Stand

Most experimenters and constructors own only one or two meters, which they use for a variety of purposes. These instruments, being rather valuable, should be mounted in some way; so that they can not roll over on their edges and, possibly, off the table.

A simple and reliable support can be made from two small iron shelf brackets, such as the chain stores sell for a few cents each. One leg is cut short and its edge filed out to fit the curvature of the meter body. A small hole is drilled in it, to match the side mounting hole in the meter frame. Both legs are then bent over to form an angle of about 60 degrees with the longer legs, which provide a broad supporting base. (See Fig. 5.)

Emergency Test-Prod

In order to take meter readings in some parts of a circuit, it is sometimes necessary to push one of the meter wires into an inaccessible corner where the fingers can not reach. In the absence of special long test-prods, a satisfactory substitute is an ordinary screwdriver with a wooden handle. Simply connect the flexible wire of the meter to a Mueller clip and snap the latter around the shank of the tool. The handle provides plenty of insulation and saves you from possible unpleasant jolts from the plate supply.

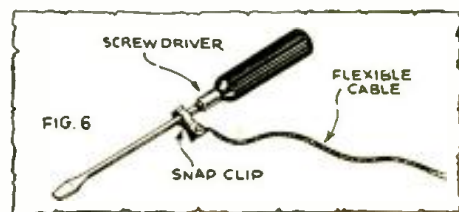

Using an insulated handle screw-driver as a "test prod".

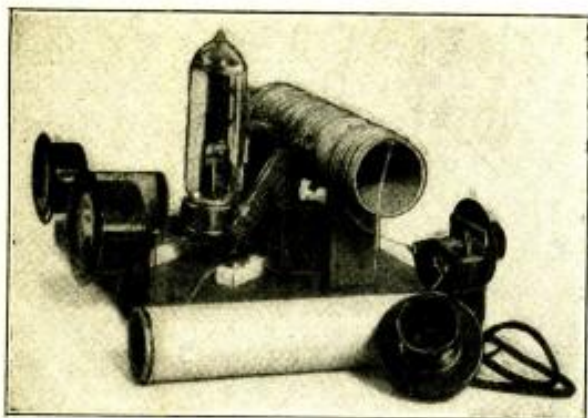

A simple type phone transmitter such as here described by Mr. Haidell.

Inexpensive PHONE TRANSMITTERS

By A. H. HAIDELL

There are many cases where small inexpensive phone transmitters are useful and desirable. Mr. Haidell explains in the accompanying article some little-known points about the simplest phone transmitters.

ONE of the most interesting phases of short-wave work is telephone transmission. Every radio amateur, sooner or later (mostly sooner) attempts to operate a telephone transmitter. The quality of modulation obtained depends upon the apparatus available and the care taken in its adjustment. Some of the radiophones on the air are not so good, while others are very satisfactory. Usually it is not absolutely essential to have perfect quality; especially when the funds available do not meet the requirements of the more complicated telephone transmitters. It is one thing to communicate with code, but nevertheless much more interesting to actually talk to a fellow amateur. By following the instructions in this article, it is possible to construct a good telephone transmitter of exceptionally low cost.

"Loop" Modulation

The principle of the type of modulation used is shown in Fig. 1. This system is not particularly adapted to high powers, but it works quite well for the low-power transmitters used by the majority of amateurs. This method is known among amateurs as "loop" modulation, and the circuit functions quite effectively if carefully adjusted. The amount of apparatus necessary is so very small that it may be said to be negligible. In fact, all that is necessary is the usual code transmitter and, of course, the microphone.

The operation of a modulator of this kind is approximately as follows: The microphone is connected in series with a coil consisting of a few turns of wire of about the same diameter as the inductance of the oscillator itself. The exact number of turns in the loop depends upon so many factors that a definite value can not be given. In the oscillator shown in the photograph, two turns were employed and the modulation obtained was very satisfactory. When the loop circuit is coupled closely to the oscillator, and the microphone is spoken into, the resistance of the loop circuit varies and, consequently, the power it absorbs from the oscillator circuit also varies. This results in an output to the

antenna which varies according to the voice fluctuations. In other words, the transmitted signal is modulated and one can communicate by voice to quite distant points. Care must be taken that the microphone circuit does not absorb

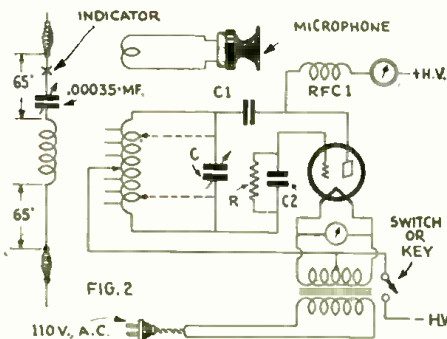

Circuit of simple phone transmitter, including antenna and modulation circuit.

too much power; otherwise the microphone may heat and be damaged. This type of modulation only works well at low power and its main advantage is low cost. If one considers the cost of the usual modulator, which is necessary to convert the average short-wave oscillator into a telephone transmitter, the use of loop modulation has its advantages.

Construction of Transmitters

Of course, the transmitter to be described functions very effectively as a code transmitter. Those contemplating the construction of code transmitters will

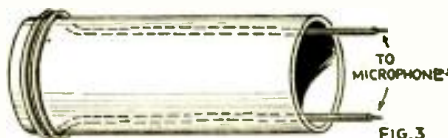

Absorption-modulation coil wound on a tube; the terminals connect to the microphone.

be interested in a description of this set. It is especially designed, however, so that it can be used for telephone transmission. Those desiring a set for telephone transmission will also be interested in this set because of its extremely low cost.

Although a 50-watt tube is shown in the photograph, any ordinary tubes can be used at first. Meters, although convenient, are not entirely necessary for efficient operation of the set; those shown in the photograph measure plate current and filament voltage. When the set is assembled and adjustments are made, one can adjust the transmitter with borrowed instruments and then remove them from the circuit if desired. If meters are used, they should be connected in the positions shown in Fig. 2.

The transmitting inductance consists of 22 turns of No. 12 solid copper wire on a piece of cardboard tubing 2 1/2 inches in diameter. The aerial coil consists of 5 turns, spaced about one inch from the main oscillating circuit inductance. This inductance is tapped at every turn; this is done by scraping the wires at the desired positions and soldering thin pieces of copper to the turns of the coil. The turns are spaced about 1/4 inch apart and the taps are soldered on in two rows, one above the other; thus giving space

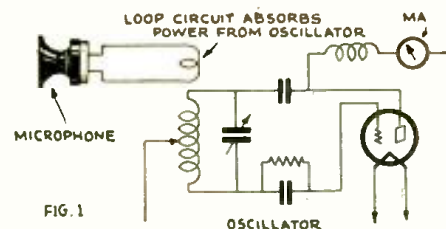

How a simple microphone "loop circuit" absorbs power from the oscillator and thus permits the voice to modulate the outgoing wave.

between the taps for the clips used in making connections with the coil.

A special feature of this set is the microphone loop circuit, which slips inside the main inductance coil. The construction of the special loop arrangement is shown in Fig. 3. A special sliding tube consists of a piece of cardboard tubing, which just slips inside the main tubing supporting the primary and antenna coils. At one end of this tubing two turns of No. 20 wire are wound and cemented in place. The tubing should be small enough so that, with the wire

(Continued on page 355)

Short Wave Converters

By RICHARD F. SHEA

Consulting Engineer

Formerly Chief Engineer, Pilot Radio & Tube Corp.

This specially written article by Mr. Shea contains complete data on a S-W converter of the new Pilot type, with band switch and coil feature. All condenser, coil winding and resistor values are given.

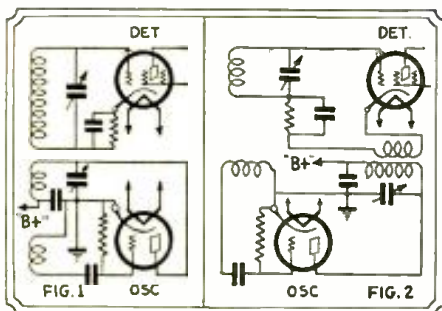

Fig. 1 illustrates magnetic coupling of detector and oscillator. Fig. 2, oscillator pick-up coil linked with a coil in cathode lead of detector.

THE last few months have witnessed a revival of interest in the well-known short-wave "converters"; and several companies have brought out short-wave receivers incorporating this principle. While many articles have been published on this subject, there still remains much to be written. It is the purpose of this article to go somewhat further into detail regarding theory and practise on this subject, and to give various practical combinations which have worked out satisfactorily.

Essentially, the short-wave converter consists of an auxiliary oscillator and a detector; the latter converts the higher frequencies to some frequency in the broadcast band, hence the name. All the newer converters perform this basic function, the fundamental difference between different makes lying in the use or omission of other accessories (such as preselectors, additional stages tuned to the broadcast frequency, etc.), and also in certain fundamental circuit differences.

Selecting Best Broadcast Frequency

In the design of a short-wave converter there are several major problems to solve, in order to get a satisfactory job; one of these is the selection of the proper broadcast frequency. The majority of converters on the market employ a broadcast frequency in the range between 550 and 1,000 kilocycles. While, theoretically, 1,500 kilocycles is a preferable frequency, from the standpoint of "image interference", the majority of commercial sets are not uniform enough at this end of the scale. Also, the use of such a high frequency means that there will be very strong second and third harmonics of the broadcast oscillator in the higher ranges of the converter. These considerations usually dictate the choice of around 550 kilocycles.

How Shall We Couple Oscillator and Detector?

Another problem is the method of coupling between the oscillator and the detector. The most popular is that wherein the oscillator and detector coils are magnetically coupled to each other, usually being wound on the same coil form. This method has several distinct advantages, the principal one being simplicity; since

it certainly reduces the number of necessary parts, and, in the case of converters covering a number of ranges by means of a switch, the number also of necessary sections in this switch. Fig. 1 illustrates this method of coupling.

Another method of coupling the oscillator into the detector circuit is that of inserting a "pickup coil" in the cathode lead of the detector. This method requires one more switch section, in an "All-Wave" job, and also more parts and space; for these reasons, it has not been used very extensively. This method is illustrated in Fig. 2.

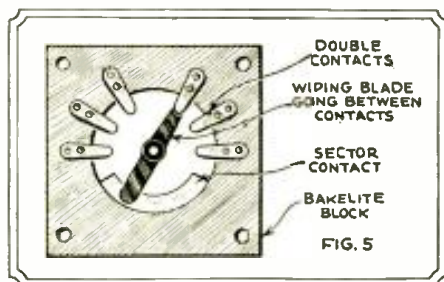

One form of switch design, having blade between contacts.

A third method employs screen-grid coupling, which is similar to cathode coupling, except that the "pickup" coil is in the screen-grid lead, as illustrated in Fig. 3. This has the same disadvantages as the other method.

Still another method of coupling the oscillator and detector circuits is by means of a "bridge circuit", as shown in Fig. 4. While it has the same disadvantages as the last two, from the stand-

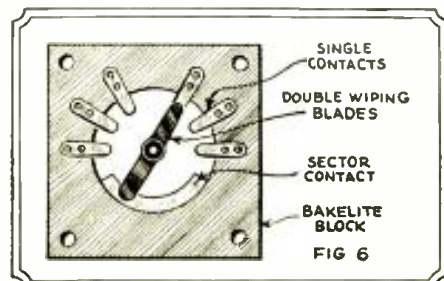

Another design of switch with double wiping blades.

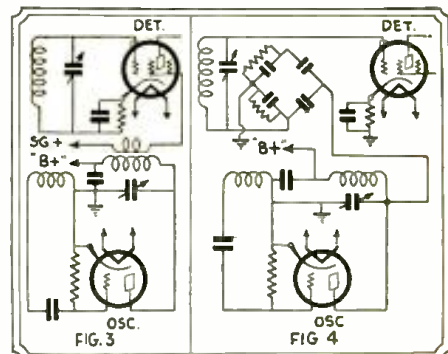

Fig. 3 shows screen-grid circuit coupling of oscillator and detector. Fig. 4 "bridge circuit" detector-oscillator coupling.

point of simplicity, it has additional advantages that will be enlarged upon later in this article.

"Image Interference"

One of the most serious problems in converter design is "image interference". This is manifested in two forms: a desired station will come in at two readings on the dial; and also, frequently, an undesired signal will come in on top of a desired signal. This, of course, is due to the well-known fact that two different oscillator frequencies will combine with the incoming signal to give the desired intermediate frequency. Since the two spots will be separated by just twice the intermediate frequency, there is a distinct advantage in using as high an intermediate frequency as feasible. However, unless additional selectivity is employed, we cannot fully eliminate this "image" effect. The easiest way of accomplishing this is the use of a stage of high-frequency amplification before the detector. Another way of dealing with this problem is the use of acceptor-rejector circuits, such as used in some broadcast supers. In these circuits, the undesired frequency (higher by twice the I. F. than the desired frequency) is always attenuated; while the desired frequency is tuned in.

Another problem in converter design is noise ratio; that is, the ratio of "background noise" to desired signal. This is quite a serious problem in short-wave work, because of the additional amplification employed. Its solution depends upon obtaining maximum gain ahead of the oscillator; so that the ratio of signal to induced (oscillator) voltage will be a maximum. It must be borne in mind, however, that there are two oscillators in a short-wave converter combination; one in the converter, and one in the regular broadcast receiver (if a superheterodyne). Consequently there is the choice of whether to put the additional gain before the detector in the converter, or before the detector in the regular set, or both. This problem will be taken up more in detail later.

Dead Spots—Their Cause

In converter design one problem which causes the engineer much grief, is "dead"

or "weak spots". These spots are generally due to one or more of three causes: One is the effect of the resonant frequency of a certain coil on another coil. For example, it may be found that the high-wave coils have a resonance falling in one of the lower ranges, and, at this point, there will be a weak or even a dead spot; this depending upon the degree of coupling between these coils. Another cause of dead spots is coupling between detector and oscillator, in some other manner than the desired one. For example, we may be using magnetic coupling between these two circuits; yet in addition to this desired coupling, there may be voltage induced in the detector circuit by either capacity coupling, magnetic coupling in the associated wiring, common coupling in ground leads and in the condenser frame, shaft, or leads, common coupling in power supply system, or similar manners. Obviously, these extraneous couplings may produce induced voltages, in the detector circuit, which may be as great or even greater than the desired voltage, and may be either in phase or out. Therefore it is possible to get a great variation in induced voltage in a single range, such as twenty to forty meters; and the induced voltage may even go to zero, where the various induced voltages from different sources buck each other. To eliminate, or minimize, weak spots it is necessary to very carefully reduce all undesired induced voltages, and to depend on only a single means of getting the oscillator voltage on the detector grid.

In most of the means of coupling the oscillator to the detector described before, there is likely to be quite serious reaction between the two circuits. In other words, when the detector circuit is tuned to resonance, it causes a change in the oscillator frequency and, since this is much sharper than the detector tuning (because of the selectivity of the broadcast set), it gives the trimmer adjustment a false sharpness; so that, to obtain best adjustment, it may be necessary to tune the two controls reciprocally. This reaction effect is much more pronounced where there is extraneous coupling between the detector and oscillator circuits, and also at the higher frequencies; for at the lower frequencies the intermediate frequency is such a high percentage of the incoming signal frequency that the two circuits are far from being in tune, so that they have little effect on each other.

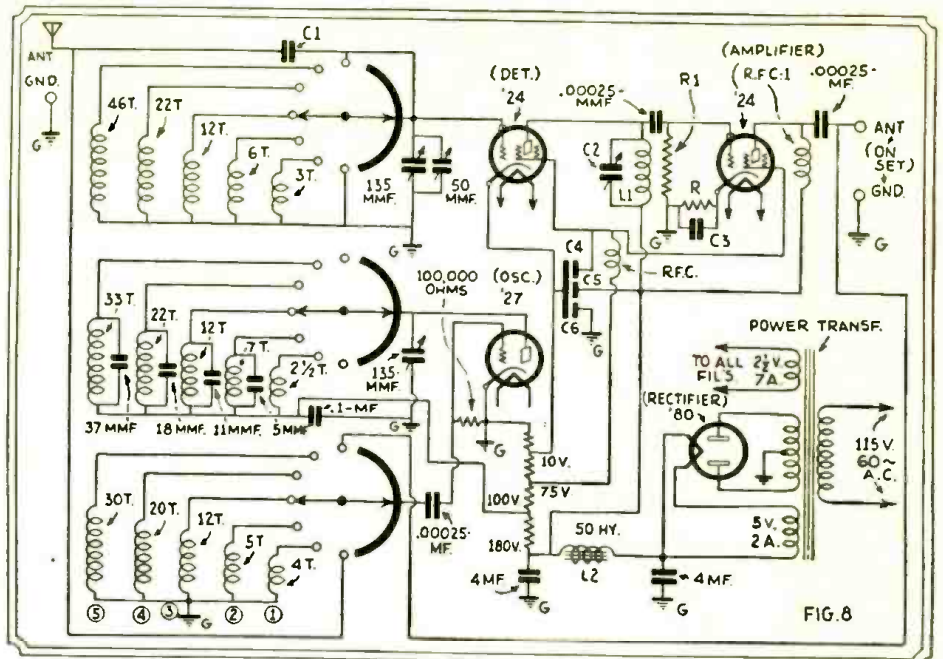

All-wave converter circuit, for which all data is included. The 3 switches are ganged and the whole circuit is similar to that used in the new Pilot converter.

Microphonic Howls

Those who have had experience in the design of broadcast supers will recall the difficulties experienced at first from microphonic howls, due to mechanical vibration of the variable condenser plates. It

the former case. In one commercial all-wave job, where the converter was housed under the same roof as the broadcast set, several special precautions were found necessary to avoid this trouble. The condenser was mounted on rubber, as was the speaker; the oscillator half of the condenser was double spaced; and, lastly, a shield was placed around the condenser to enclose it against air vibration. All these precautions serve to illustrate the seriousness of this problem. Even where the converter is in a separate cabinet, it can produce a howl if placed on top of the receiver cabinet, or even on the same table. To overcome this, it may be desirable to "rubber mount" either the condenser, or even the whole converter.

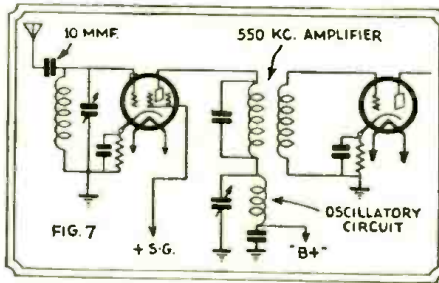

Suggested experimental circuit for autodyne oscillator, one tube serving both as detector and oscillator.

The foregoing has been almost entirely devoted to a discussion of the problems arising in the design of short-wave converters. I will now go into more detailed description of constructional features and circuit data.

will be interesting to note that this problem is much more pronounced in short-wave converter design than in the case of broadcast sets, since there is much more amplification following the oscillator in

Coil Switches to Replace Plug-In Coils

The very basis of satisfaction in any attempt to cover a number of ranges in

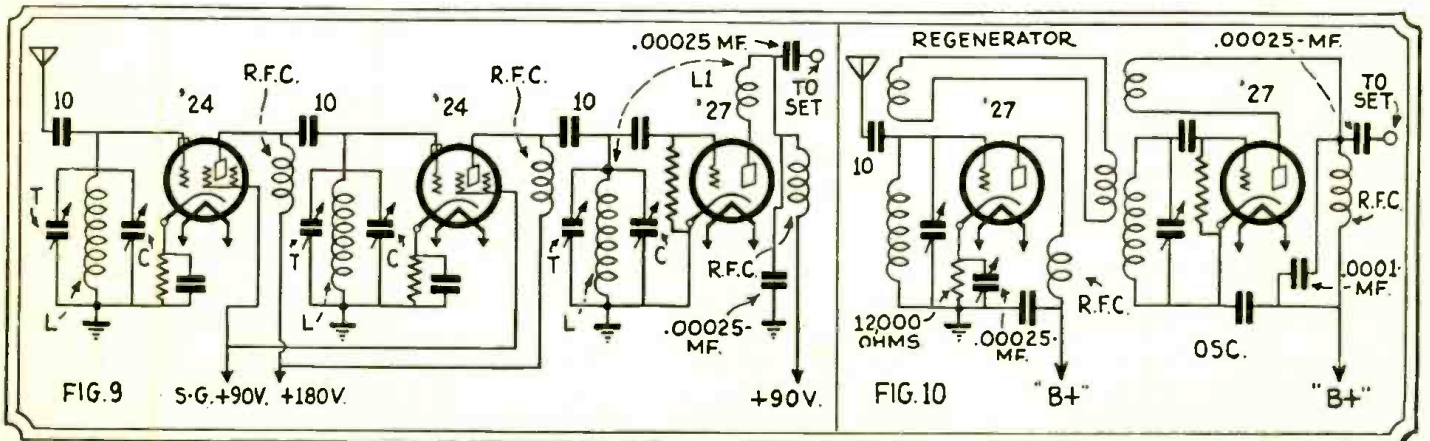

Fig. 9—Special short wave converter, having two stages of T.R.F. The individual stages are mounted in separate shield compartments with the condensers ganged together, giving 1-dial tuning. Fig. 10—Novel converter tried successfully by the author on 3,500 kc. amateur phone reception; it employs regeneration in an unusual manner.

A Signal Frequency Amplifier for S. W. Converters

By E. T. SOMERSET,

Associate I. R. E.,
English Call G2DT.

FROM the above somewhat abbreviated title it may be construed that what is about to be described is for use only with short-wave superheterodyne converters. This is not so; as it will give every satisfaction when used with the author's combination long- and short-wave receiver (described in the Feb.-March issue of SHORT WAVE CRAFT) or his "one-coil superhet converter" (same issue), as well as with any short-wave super or any short-wave regenerative receiver, as used by so many amateurs the world over,

As its name implies, this piece of apparatus is for amplifying a short-wave signal at *signal frequency* and passing it on to the first detector of a converter; to obtain the biggest possible amplification, we use a screen-grid tube and tune its grid circuit. Another important part this amplifier plays, is to act as a blocking stage and thus prevent the ether being rent with howls when someone bleeps. Yet another important aspect (and this is really the *pièce de résistance* of the amplifier) is the fact that it effectually increases selectivity; since the first detector all by itself is a mighty small buffer against the whole world.

As many of my readers are, doubtless, getting wonderful reception by means of their built-up or purchased converters in conjunction with their B.C. receivers, they may, quite naturally, ask what is the use of still more amplification and an added tuning control? The answer is that, when conditions are not all that they might be or when the noise-to-signal ratio is high, this amplifier will impress a stronger signal on the grid of the first detector; with the consequence that the intermediate frequency amplifier (by which I here mean the T.R.F. stages of the broadcast receiver) need not be made to amplify so much. This in turn means reduction of the noise level, a decided advantage at times.

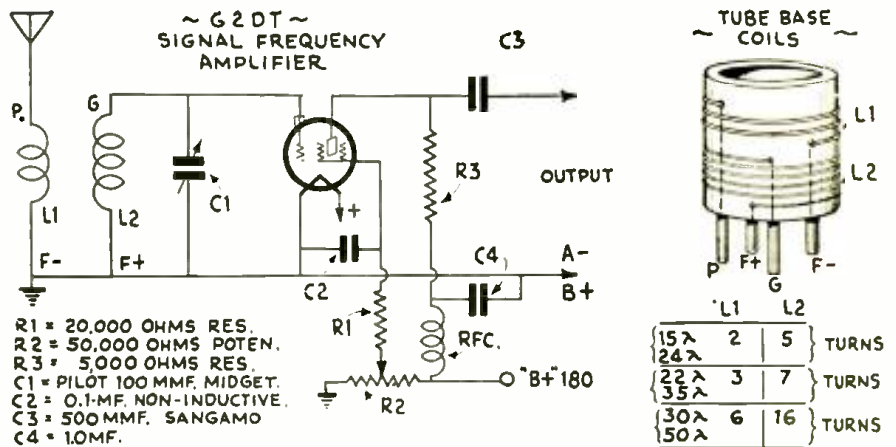

Before going on to its constructional details, I would just like to draw attention to a mistake appearing on page 353 of SHORT WAVE CRAFT for Feb.-March. It is just possible that some readers may have had trouble with the converter described therein, because condenser C1 in the *theoretical* diagram is shown as a fixed condenser; this should, of course, be *variable* as illustrated in the plan view.

Turning now to the diagram of the signal-frequency amplifier, it will be seen that it is extremely simple; the coils may be wound on either tube bases or "Pilot" short-wave coil forms. It is built into a standard aluminum shield can and all components, except the coils, are mounted inside the can. If tube-base coils are used, a "Pilot" UX socket is used as coil holder and a round hole of correct size is cut into one side of the can. This permits the socket to be mounted inside, so that its round portion protrudes through the opening; with the result that the lid of the can be left permanently in position need not be dis-

turbed when it is desired to change coils, for these will now be outside the can.

It is recommended that a midget condenser be used for C1 and that a cover be used for both the screen-grid tube and the standard short-wave R.F. choke. If these precautions are taken, as well as the use of the voltage-dropping resistors R1-R3, (which also act very effectively as de-couplers) no trouble whatsoever from instability should be experienced. A National type "B" vernier dial will serve admirably and tuning will not be found to be at all sharp.

The output of the amplifier passes through the plate blocking condenser C3 (which must be a good one) and can conveniently be taken out of the can on the opposite side from the coil socket. This goes to the "Ant." binding post on the converter or regenerative set; and the "A—" goes to the "Gnd" (or common negative) of the converter. Tune the converter as usual, and then tune to resonance with this amplifier—all extremely simple.

A New "Bug" Key for the Amateur

PROBABLY the most desired possession of every transmitting amateur is a "Bug" or Vibroplex key. To those not initiated into the mysteries of this bit of equipment, it might be explained that a "bug" makes its own "dots," but leaves the formation of the "dashes" and "spaces" to the operator. The key operates with a lateral motion—moving it to the left makes positive contact for the transmission of a dash and moving it to the right sets in motion a small pendulum which makes a rapid series of dots—the number depending upon the length of time that the knob is held to the left. The rapidity with which the dots are made depends upon the position of the weight on the pendulum and

the tension of the operating spring. As will be readily understood from even this brief explanation, the "Bug" is me-

chanically operated — and, although sturdy and steadfast in the performance (Continued on page 361)

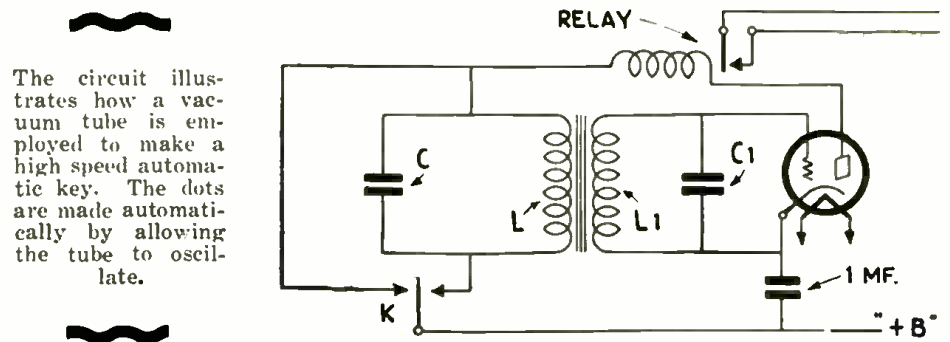

The ALL-WAVE SUPER-BOOSTER

By H. G. CISIN, M.E.

MANY radio set owners have expressed the desire for an easily-built accessory which will increase selectivity and at the same time improve reception. While the correctly designed wavetraps aid materially in separating stations, its use generally results in a decrease in volume.

The All-Wave Super-Booster not only improves selectivity, but it increases volume as well and gives greatly improved reception. It can be used with any standard A.C. broadcast receiver. Furthermore, it increases sensitivity and distance-getting ability.

Converts Any Broadcast Receiver for Short Waves

An additional feature of the Super-Booster is the fact that it can be used to convert any broadcast receiver into a short-wave set, by merely substituting the desired plug-in short-wave coil for the three-circuit tuner used to cover the broadcast band.

The All-Wave Super-Booster utilizes two '27-type tubes, one as a detector and the other as an oscillator. A regenerative detector is used with a fixed tickler. The use of regeneration materially increases the sensitivity of the first tube, sharpens the selectivity and on short waves, permits the reception of C.W. signals. The incoming signal is rectified by the first tube, and the audio-frequency output of this tube modulates the oscillator, which is adjusted to the desired frequency of the receiver. A plug-in type three-circuit tuner is used at (3). The secondary of this coil is tuned by one of the new compact light-weight Cardwell "Midway" condensers. Regeneration is controlled by means of a 35-mmf. Cardwell "Balancet" condenser (8). A fixed impedance coil is used at (18), tuned by a second "Midway" condenser.

The grid leak is a 2-meg. (or larger) Durham metallized resistor, and the grid condenser is a .0002 mf. Aerovox condenser. Midget condensers are also used at (14) and (22). The R.F. chokes employed at (9) and (21) should resonate at about 600 meters. The condenser (20) used to by-pass the R.F. choke (21) is a 0.5-mf. fixed condenser. A similar by-pass condenser is also used at (11). It will be noted that the audio transformer (10) is connected with its primary and secondary windings in series, *aiding* each other. The purpose of this is to offer as large an inductance as possible to the audio-frequency output of the detector. The metallized resistor at (13) serves to reduce the voltage on the plate of the tube (7) from 90 volts to 40 volts. The Electrad "Truvolt" resistor at (17) provides an adjustment for regulating the signal response. Amperites are provided in the filament circuit of each '27 tube to give the booster more stable operation and to increase

This device will increase selectivity and improve performance of the radio receiver and also adapts any broadcast receiver to "short wave" reception.

the life-span of the tubes. A 2½-volt filament supply is needed for the tubes and a plate supply of from 45 to 90 volts.

Putting Super-Booster Into Operation

After the Super-Booster is connected up, it may be put into operation as follows: the receiver is first adjusted to that position of the tuning scale where maximum sensitivity and selectivity are

The fixed condensers are mounted, then the two R.F. chokes, next the amperite mountings and finally the binding posts. Fahnestock clips may be used instead of binding posts, since they cost less and are equally efficient. The Durham metallized resistors are soldered in place during the process of wiring.

The panel is prepared next. Mounting holes are drilled for the midget condenser (8) and the Electrad Truvolt resistor (17)—also three mounting holes and a shaft hole for the Cardwell "Midway" condenser (4). Three holes are drilled at this time to fasten the panel to the baseboard. Parts (4), (8), and (17) are mounted and the panel is fastened to the baseboard by three wood screws. The Booster is now ready for wiring.

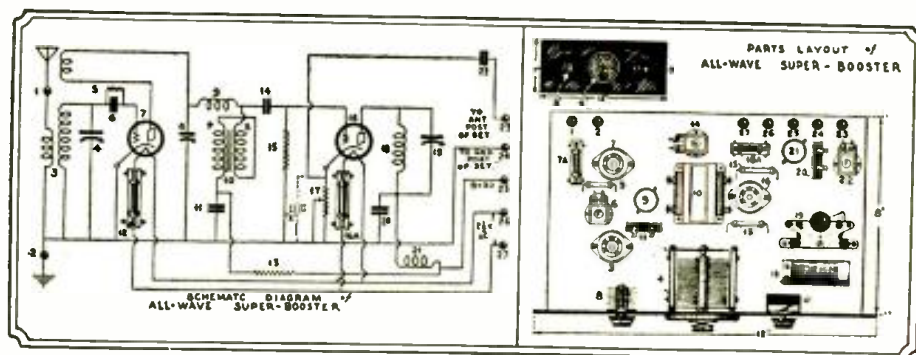

Hook-up and placement of parts in Mr. Cisin's all-wave super-booster. Can be used to adapt any broadcast receiver to pick up short waves.

obtained. This is generally around the lower broadcast wavelengths. The circuit consisting of condenser (19) and coil (18) should then be tuned to about the same wavelength as the receiver, by observing the position of the condenser rotor plates. The signal is next tuned in, with the main tuning condenser (4), from a strong local station. Condenser (19) should then be readjusted for maximum signal strength and locked with the Cardwell locking device. The Electrad resistor (17) is next adjusted for maximum response. For distance reception, condenser (8) is used in the conventional manner to control regeneration. Volume is regulated by means of the volume control on the receiver. The assembling and wiring of the booster will now be explained.

Assembling the All-Wave Super-Booster

The position of the Cardwell "Midway" condenser (4) is at the front center of the baseboard. The three sockets are mounted as indicated. Then the audio transformer (10), is fastened in place, directly behind the position of the variable condenser. The "Midway" condenser (19) is mounted on its end; using brackets, so that it can be regulated by a knob from above, as shown.

The filament wiring is put in first, from posts (26) and (27) through the respective Amperites to the heater socket terminals. Filament wiring should be twisted. The usual procedure is then followed, wiring in the grid circuits first, then the plate circuits, next the cathodes, then the by-pass condensers and finally completing the wiring from socket (3) to antenna post (1). Corwico solid core Braidite is used for all wiring.

It will be noted that a 5-prong socket is used at (3) for the antenna coupler. Two of the terminals provide for the tickler coil; one for one end of the primary; one terminal for one end of the secondary and one for the common connection between primary and secondary, leading to the ground. The antenna coupler is a standard three-circuit tuner with fixed tickler, but provided with a plug-in base. This is used so that the Super-Booster may be utilized as a short-wave adapter, by substituting various short-wave coils in the place of coil (3).

In some cases, it may be found desirable to shunt the Electrad resistor (17) with a 0.1-mf. by-pass condenser, as indicated by the dotted lines at "X", in order to clarify the signals.

(Continued on page 364)

The PROPAGATION of SHORT WAVES

ACCORDING to this assumption, there hangs over the earth on the *day side*, a multiple "umbrella," which contains besides the lines shown, all the intermediate stages. At the same time there is a possibility of communication between any two places on the surface of the earth, which are touched by the same line of conductivity. The lines themselves are given continuous excitation from solar electrons.

In the course of a day, in view of the rotation of the earth, each point on the surface of the earth describes a fixed path in an umbrella-like conductive structure, and finds operating conditions periodically changing. Besides the daily revolution, the earth annually completes a circuit about the sun; whereby there is caused a constantly changing angular inclination of the earth's axis to the sun. This second motion of the earth in the cosmically-located network of conductive lines (which are therefore fixed in space) is the cause of the changes in range which occur during annual periods.

The previous considerations dealt with the common features of the propagation of all short-wave frequencies; and it now remains for us to consider the principles governing the reception of the individual frequencies. From the collation of numerous observations, we find that the reflection curves are the same for conduc-

By ROBERT MEYER,
of Hamburg, Germany
(Conclusion)

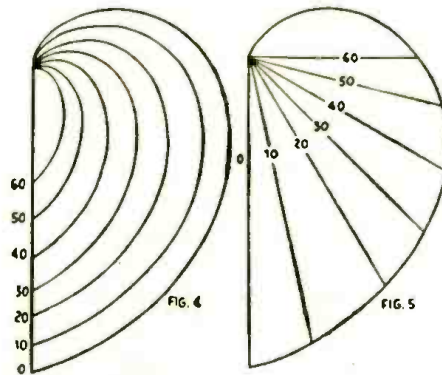

Diagrams (Figs. 4 and 5) used by author to explain action in short wave propagation.

tive lines of all frequencies; but that they are differently oriented in each case. If known ranges of different frequencies, from the same point on the surface of the earth, are collected in a diagram, there results a separation of the frequency lines according to a uniform principle, as shown in Fig. 4. The higher the frequency, the longer the reflection path,

but the curve itself always remains the same. The only difference is the angular position of the path; so that a "spectral" dispersion of the solar electrons must be presupposed, analogous to the dispersion of light in a prism. The process maintained in Fig. 4, is shown again in Fig. 5; but in such a way that the curves are covered and the hitherto coinciding facts of (compass) direction are different in the angular position. Now a measurement can be undertaken on this graph and it appears that, for 15 degrees difference in direction, there is a wavelength difference of 10 meters. The previous diagrams, which were for the 20-meter wave, can now be filled out on the basis of curves in Figs. 4 and 5 for all frequencies.

The writer's theory therefore involves the assumption that there is, for every short-wave frequency, a network of conductive lines, fixed in space. I imagine these networks as being formed of spectrally dispersed solar electrons, serving as a non-resistant conductor (i.e., one with no loss) for the corresponding transmitting frequencies. Then the night side of the earth gives a path for a signal only if it is touched by a conductive line formed on the day side of the earth. If there is no conductive line, there is no possibility of communication.—*Wissen und Fortschritt.*

20-Meter Reception In Europe

By HANS LUCAS, DE798

FROM various sources, it has been often pointed out that (contrary to theory) 40-meter reception is possible, even at night, down to distances as short as 90 miles and even shorter. We also have similar deviations in the reception of PA, on (QRB 2y0 to 240 miles) until over an hour after sunset. Likewise the G's (QRB 360 to 600 miles), which, however, could also frequently be heard until midnight and even later as strongly as R4 (scale of 10) on detector and one audio stage. By a series of experiments at the end of July, I endeavored to learn whether regularities in the case of 20-meter reception could be determined within the limits of Europe and, if so, what? (QRA near Erfurt, Schnell circuit with one A.F.)

Observations were made especially between July 20 and July 30, when banks of warm and cold air and regions of interference were moving rather fast over northern and central Europe. The reception of the European transmitters was therefore very unequal. Unfortunately, only the weather maps could be used for evaluating my observations; yet I believe that I have found some rules, which I should like to offer for criticism; in order, perhaps, to secure an exchange of experi-

ence, since this question can be clarified only by many observations.

Here are the results:

(1) If the receiver was in a sector of warm air, then before sunset adjacent regions, within 210 to 600 miles, could be heard well (R4, R6 to 5). With the sunset, fairly strong QSB set in (e.g., the G's dropped from R6 to 1). An hour later, nothing more was to be heard.

(2) In an extended area of low pressure (including both transmitter and receiver), during twilight the stations outside the center (QRB 360 to 600 miles) had excellent sound strength up to R7!), with some fading, to be sure. On the other hand, stations inside the central area were softer and had strong QSB. How conditions were during the night in this state of the weather, cannot as yet be said.

(3) Reception was good when a north-and-south bank of cold air was near the receiver. While, under the weather situations just mentioned, only stations to 600 miles could be heard, the low-pressure zone was now enlarged; so that even the further stations could be heard. And indeed those countries showed the best QRK's, which were on the same side of the bank of cold air as the receiver.

If the receiver was actually in the region of the body of cold air moving west-to-east, then Gs, Fs, CTs, were to be heard, and especially numerous in the twilight. If the receiver was still in front of the bank of cold air, then it was OH, EU. The shortest distance during twilight was 360 miles. The stations up to 1,200 miles increased in volume with distance. QSB of long period. (During this state of the weather, was the only time during the experimental series that I had overseas reception. SU, FM, W 1 2 3 VQ Uganda, 10.10 P.M. Central European time.)

(4) Finally, I should like to mention one more condition of the weather: high pressure over Spain, low pressure over the Baltic Sea, the receiving station lying between the two. After sunset only the stations around the rim were audible: CT, EU, OH with QSB R5 to 2, while the volumes gradually decreased with the beginning of darkness.

These are not, of course, final results. We must investigate whether these observations are sound, and similar results have also been made elsewhere. Likewise, whether and how much the season and the activity of the sun have an influence.—*Funk Bastler.*

"KEYING" With NEW Vacuum Contact

By HERMAN KOTT

Engineering Dept., Burgess Battery Co.

ANY telegraph key, whether it be the usual telegraph key with small contacts or the heavy-duty radio type with worn-out contacts, can be converted into a flame-proof, easy running power key by the average handyman. The conversion is made possible by a new and ingenious form of contact known as the Burgess vacuum contact, which handles a maximum of current with a minimum of actuating energy.

Add new vacuum contact to your old key and handle "power" without sparking!

the contacts to close. The mounting and the application of external pressure determine whether the contact members are normally closed or open, for the given type of work.

There are various ways in which the

connecting link is provided with a slot (rather than a round hole tightly fitting about the glass rod), there is sufficient play so that the key may be set for any desired swing. Some operators may like very little swing, while others may like considerable swing; but, in either event, the vacuum contact operates when the key is slightly depressed, since it is the releasing of pressure, rather than any positive pressure, that closes the circuit.

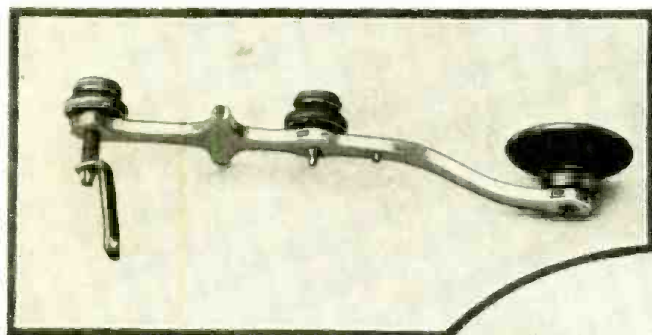

Above: Small metal link added to old key for actuating new vacuum contact. Below and right—two views of key frame.

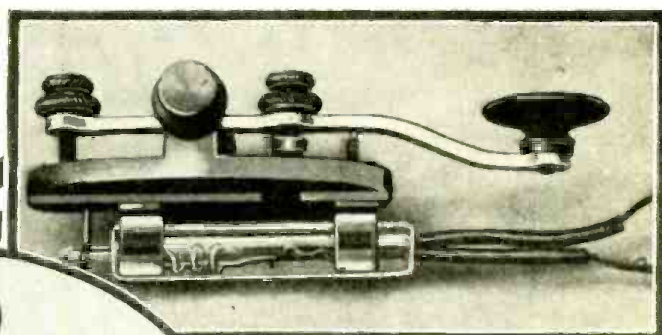

Above: Side view of "revamped" key with Burgess vacuum contact in clips. Below: Under-side of key with vacuum contact.

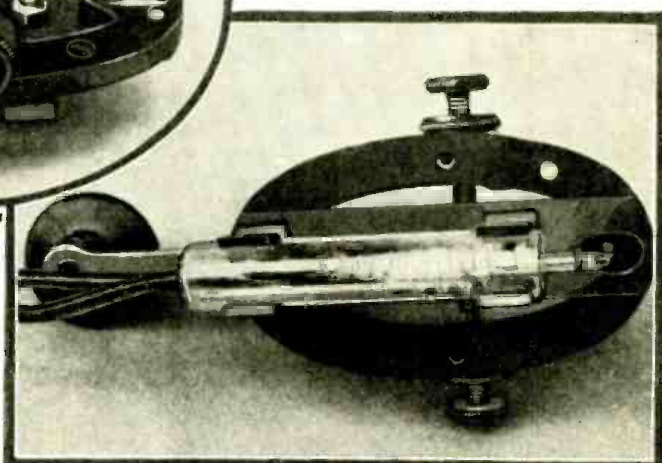
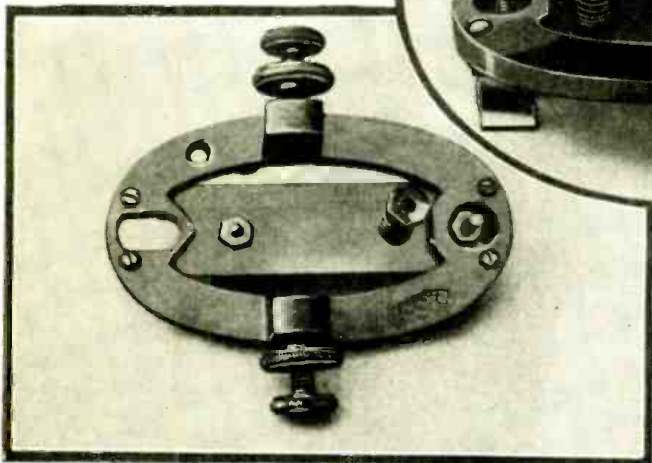

Briefly, the Burgess vacuum contact is a German development now available in this country. It comprises an evacuated glass tube containing a pair of copper contact members which are actuated by a slight pressure on an external glass rod. The device is based on the elasticity of a special glass bellows, providing the necessary flexing action for the separation of the contact members. While the contact members are normally in contact, due to the pressure of a spring, the device may be so mounted that constant external pressure is applied on the glass rod, causing the contacts to be normally separated; while the releasing of that pressure or the application of a counter pressure causes

vacuum contact may be applied to the usual telegraph key. In fact, there is considerable latitude here for the display of ingenuity. The accompanying photographs indicate one method. It will be noted that the vacuum contact fits in a pair of cartridge fuse clips mounted on a brass strip beneath the frame of the key. The extension rod of the vacuum contact engages with a lever that connects with the adjustment screw at the rear end of the key lever; so that downward pressure on the extension rod results in the vacuum contact being normally open. As the key is depressed, the pressure is released on the glass extension rod, permitting the vacuum contact to close. Because the

The Burgess vacuum contact will handle up to 6 amperes continuously or 8 amperes intermittently, at 220 volts. It will operate up to a speed of 40 makes and breaks per second, if desired. So delicately balanced is this device that it requires only 6 ounces on the glass stem to operate the contact, or, in terms of motion, only .02-inch. Because the contact members are in vacuum, there is practically no sparking or arcing, and positively no corrosion in the absence of air. On heavy loads the contact may be shunted by a small mica condenser of very low capacity. The device makes and breaks any circuit positively and cleanly, without the chattering or hang-

(Continued on page 356)

More About Mr. Doerle's 12,500 Mile Set

IN the last issue, Mr. Doerle described at length his interesting short wave receiver, which is capable of picking up signals from almost anywhere, depending on the parts used. It goes without saying that if cheap parts and an insensitive pair of phones are used, that one cannot hope to hear far-distant signals. Let's go on with Mr. Doerle's tale:

Let it be understood here that all tube-base coils are not going to act alike in the detector stage. Some bases are made of genuine bakelite, while others are made of an extra hard "tar" or "composition". You will probably appreciate the fact better if you get some experience in drilling small holes in these bases with the use of a power-driven drill press. In some instances, the drill must be forced for cutting action; while in others, the drill eats in as though it were going through cardboard.

"What" Tube Base Is Important

But you will probably say—"What difference do tube bases make?" Here is the explanation. Since we want a maximum signal voltage existing between the grid and filament of the detector tube, that means the oscillating circuit should have a maximum impedance (for it is a tuned circuit); and, if a high resistance is in parallel with the oscillating circuit (the losses constituting part of this resistance, because the condenser tuning across the coil also has losses), this resistance determines the voltage drop from grid to filament. Not only for this reason do we want "low losses" in the oscillating circuit, but for another which regards the amount of feed-back energy from the plate circuit, via the tickler coil and the throttle control condenser. The lower these losses, the smaller can be the tickler coil and feed-back condenser capacity. To hold the wire in place on the coil forms use a few drops of shellac or rubber cement.

Now that the oscillating circuit has withstood the fire, and emphasis has been laid on the importance of cutting down its losses to a low value, shall we now throw away our labor and have a poor, insensitive receiver, by taking no precautions in the selection of other parts? By no means, and we intend to fight until the globe is encircled and we can hear the "peeps" from a "5-watter" at

the 12,500-mile meridian. We started out after signals, records, "logs", and the whole field of short waves to show the "rich" man that a "super" midget radio still exists in poor Lazarus' field.

That R.F. Choke—Its Pedigree!

Now, in our discussion we are near the audio-frequency transformer and our eyes immediately behold an R.F. choke. Gee, what a mean thing for the temper; but, at any rate, 300 turns of No. 36 D.S.C. magnet wire, close-wound on a $\frac{1}{2}$ " wooden dowel, will choke the R.F. current out of the transformer primary,

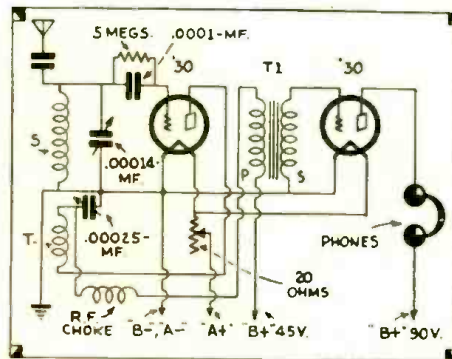

Circuit used by Mr. Doerle for the 2-tube "globe circler".

even at 20 meters. This can be verified by pressing the phone cord in the hand while the set is operating. If no change occurs in the received audio notes, the choke is performing its duty.

Try Different Grid Leaks and Condensers!

Try different leak-condenser values; by the time you have done this and have soldered some of these grid-condensers in place and used leaks thereon, you will probably give up in disgust and say, "Aw shoot! Let's take the other fellow's values to save time and trouble". After going through part of such an experiment, even to getting knuckle burns from the hot iron, take a tip and use the values given herein—5 megohm leak and .0001-mf. grid-condenser. These values will make the receiver very sensitive and, if you listen in the phones, to notice how

the background-noise level comes into prominence, when using the throttle condenser on increasing its capacity for feedback, you will greatly commend the receiver for its sensitivity. Also notice the "softness" of feedback (no spilling over) with "power plus" and "free wheeling". Aren't you getting anxious to "work" one of these receivers?

As to the audio transformer, we can't boast for any type; but a good 5 to 1 ratio and a hefty type, will certainly make the signals more prominent in the phones. Oh! that the day would come when radio parts would be sold by weight, and prices could be vetoed! Phones! phones! and we must have a pair, but let's not be guilty of innocent blood. Just buy a pair large enough to cover nearly the whole ear and, together with that, with enough weight. The "skinny make" of phones always give the signals a mouse-squeak background, at least that's been my experience.

Efficiency of New Battery Tubes

Didn't we say in the beginning that power should not be wasted? Well, let's back up our words with action and use the '30 (2-volt filament) type of tubes—the tubes with the '99 economy, but '01A amplification and output. Can you imagine this economy—two dry cells and 90 volts of "B" battery for at least six months of pleasure at a cost of \$2.50—only about \$0.50 a month!

Winter is coming; short-wave stations are growing more numerous; and the time to build this "super midget" and get a long "log" of stations is now.

Suggestions and Parts

The simplicity of the hook-up and photo has warranted us not to give a mass of details for constructing this receiver; for we believe that by so doing, the ingenuity of the builder has free course with the parts he may have available. The tubes burn at a dull red color when two volts are impressed on the filaments.

Before proceeding further, the circuit is checked against the wiring diagram, preferably with a continuity meter (voltage meter with series battery or ohmmeter).

IN OUR NEXT ISSUE:

A 17 to 300 Meter Short Wave Receiver, by Dale Tisdale.

Building an S-W Super-Het, by A. Poltheim.

The Superregenode with the New "6 Volt" Tubes, by Clifford E. Denton.

A Novel Filter for Short Wave Receivers, by Henri F. Dalpayrat.

A New Transmitter Hook-up for Ultra Short Waves.

The Blanchard Short-Wave Converter—How to Build It.

Short Wave Equipment for the Serviceman, by Clyde A. Randon.

Simple Transmitting and Receiving Sets for Ultra-Short Waves, by Dr. Kurt Nentwig, Berlin.

Experiments With Ultra-Short Waves, by Robert Kratzenstein, prominent European expert.

Stabilizing Frequency Without Crystals, by C. H. W. Nason.

A Tuned R. F. S-W Receiver, Using the New '39 R. F. Pentodes, by Clifford E. Denton.

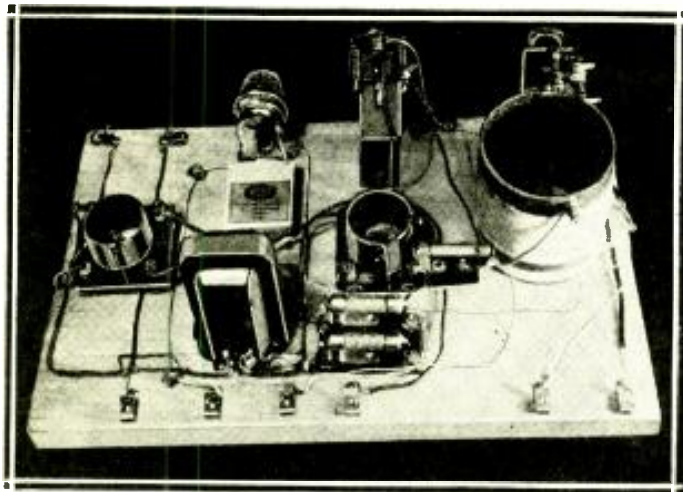

A SIMPLE and Inexpensive "AMATEUR BAND" RECEIVER

By O. G. NELSON

Many readers have requested data on building an "amateur band" short wave receiver and we are pleased to present this article by Mr. Nelson.

Above: Rear view of "amateur band" short wave receiver, here described by Mr. Nelson.

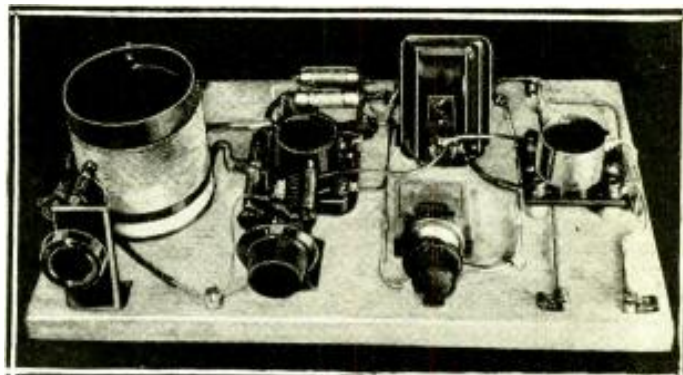

Right: Front view of Mr. Nelson's short wave receiver, particularly suited to reception on the "amateur band".

THIS two tube receiver is designed to receive amateur stations on the 1750- and 3500-kilocycle bands. These stations broadcast both phone and C.W.

Amateur radio is primarily a "hobby" and as such is extremely interesting, entertaining and instructive. In order to enjoy amateur radio to the utmost, the code should be mastered; this can be done by practicing on a buzzer set with another person until it is understood thoroughly. "Volunteer stations" can be picked up with this amateur band receiver. These stations send code lessons at frequent intervals, and they operate in the 1750-kilocycle band.

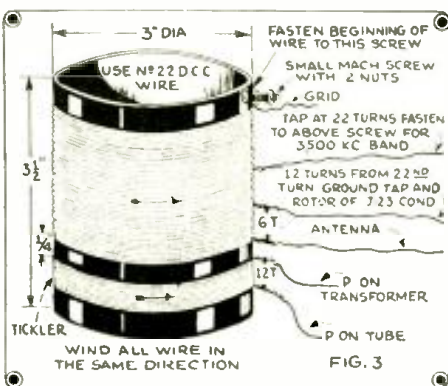

One of the brass supports used for mounting variable condensers and resistors.

- 1—A.F. transformer (ratio unimportant);
- 2—1-ampere filament ballasts (for 201-A tubes);
- 2—tube sockets, UX type;
- 60 ft. D.C.C., No. 22 wire for coil;
- 10 ft. of hook-up wire;
- 2 dozen round head wood-screws (for holding parts to baseboard).

The first thing to do is to obtain a suitable baseboard. Then the L-shaped mountings are fastened in place. These mountings are made of brass (see Fig. 2). A mounting is usually furnished with the Clarostat; but two additional mountings for the variable condensers C-1 and C-2 will have to be made. Arrange and fasten down all parts as shown in the diagram, leaving the coil until the last.

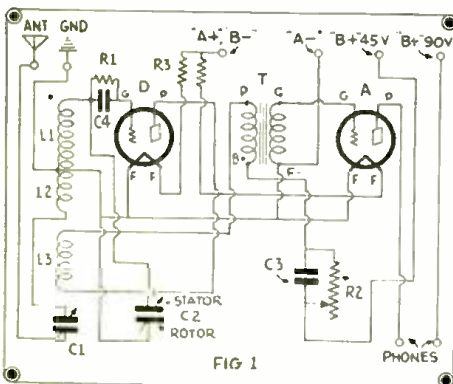

The details of the tapped inductance used in Mr. Nelson's "amateur band" receiver.

The beginner is always hampered by complications and expense when he attempts to construct a suitable receiver. The receiver described here, however, is easily constructed by anyone with the

least knowledge of radio. Even when using first-quality parts, the cost of the receiver is low.

The following is the list of parts required:

- 1—Wooden baseboard 9" x 14" x 3/4";
- 3—L shaped mountings (see Fig. 2);
- 1—Cardboard tube (for winding of coil —see Fig. 3);
- 8—Fahnestock clips;
- 1—23-plate midget condenser, .0001-mf., with knob;
- 1—small capacity aerial condenser (Pilot J-5 is satisfactory);
- 1—Clarostat high-resistance, regeneration control;
- 1—1-mf., fixed condenser;
- 1—.002-mf., grid condenser;
- 1—2-megohm grid leak;

The small-capacity aerial condenser need not be purchased by anyone who has the slightest mechanical ability. One can use a pair of 1/2" x 1/2" brass angles, separated about 1/32 inch; the thickness of the brass should not exceed 1/16 inch. For those who wish to purchase the aerial series condenser, the Pilot J-5 is recommended.

The coil is wound on a cardboard tube, 3" in diameter by 3 1/2" high. (See Fig. 3.) The coil can be fastened to the baseboard by fitting a piece of wood snugly on the inside of it, and then screwing the piece of wood to the board.

Connect all wires as shown in the diagram, making all connections as short as possible.

(Continued on page 364)

How ARE Short Waves Propagated?

(Conclusion of F. Bödigher's article in last issue)

UNIFORMLY dry air over transmitter and receiver seems to be the best condition for good "DX" (distance) radiation (by day there is strong interference by increased absorption). Conditions change with the increase in moisture in high strata above the transmitter or receiver (formation of *cirrus* clouds). The "DX" possibilities are then strongly limited; but close communication (say, over distances found in Europe) is still possible at times. A high degree of moisture near the ground has apparently little influence, if the air above is dry and uniform.

It is a matter as yet undecided, whether the relative moisture of the air or the presence of a smooth surface (lack of uniformity) plays the decisive part. There is much to be said for the latter assumption.

Appearances are such as to justify a hypothetical explanation as in Fig. 5. One might assume that in the passage through unlike strata, a diffusion of the radiation occurs. The sharp angle of the maximum radiation is broadened, the energy accordingly diffused. One hears signals more weakly, but possibly in a much wider zone. For "DX" distances the energy is weakened too much, if the diffusion occurs directly over the transmitter, but for slight distances (Europe) it is still sufficient. One hears from European distances more weakly than at the most favorable times; but one hears at a time when one normally can no longer expect close reception, because of the movement of the zone of audibility, which has already occurred.

It is another matter when the diffusion occurs only over the receiver, while the radiation is not limited over the trans-

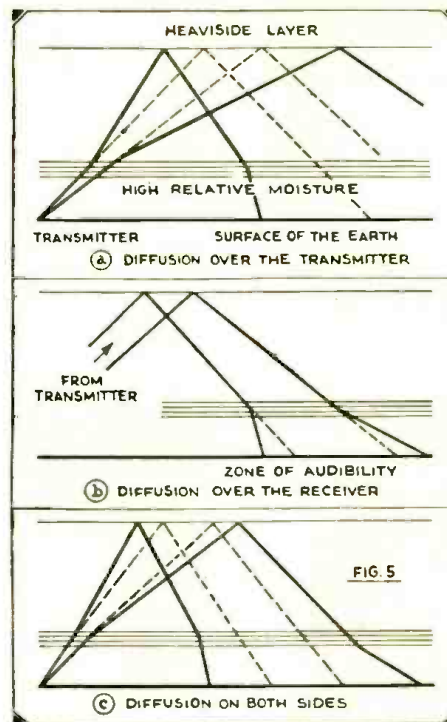

Assumed diffusion of energy by strata of high relative moisture; normal course of radiation in dotted lines. For the sake of simplicity, a straight course of radiation and reflection was drawn, instead of indicating refraction.

mitter. Then one can hear "DX" stations, though to be sure not so well as at the most favorable times; but he can determine that he hears at the same time from more countries, from far wider regions, than in the case of "good DX weather". To be sure, there is then little prospect of successful activity on the

part of one's own transmitter. Naturally the conditions are worst when diffusion occurs over both transmitter and receiver. The weather conditions mentioned therefore bring a widening of the zone and a reduction of receiving intensity. The frequently-mentioned "air pressure" is of significance only so far as it plays a part in the movement of air and, thereby, in the moisture conditions in higher strata. The same statement holds for the temperature. Meteorological conditions in the intermediate stretches are entirely of no moment. The radiation runs along in strata of the atmosphere, which are far higher than those in which meteorological processes occur (30 to 60 miles, compared with at most six miles, below the *stratosphere*, in which conditions are constant).

The energy diffusion by strata of high relative moisture at a rather great height is, we must again insist, a theory, which is justified on the basis of the phenomena observed. An explanation of how the energy diffusion occurs cannot yet be given. Therefore I can as yet merely say: "It is as though . . ."

Therefore the broadcaster strives in vain, if he tries to improve the reception of the ground wave, in this or a somewhat greater radius, as against the reception of the space radiation of strong distant stations, by competition in the output of energy. The improvement also strengthens the distant stations, and the zone of "space radiation" is widened. Since the space radiation alone is in question in distant reception, even on long waves, the formation of zones and their shifting, together with the atmospheric conditions, can be perfectly observed in the case of long waves.

All-Electric, Single Dial Tuning S-W Super-Het.

(Further information on K. König's set described in last issue)

(Concluded)

TO avoid mistakes, the terminal C for the negative direct current is marked by a smooth lug, and P for the positive heater current by a wavy lug. The rectifier system is provided with external leads. One of the transformer terminals (8 V) we connect directly to terminal A of the rectifier system; the other via resistor R17 with B, in order to avoid overloading the first electrolytic condenser C23.

Regarding the block condensers, there is a little to add to that already mentioned in the first part of the article. The capacity of C19 is not 10 but 8 mf.; and C20 is 12 mf. for C19, because of the limited space, three high-voltage blocks were used; one of 4 mf. and two of 2 mf. each. C17, C18, C20, C21, and C22 are contained in the condenser block. For C20, capacities of 6, 4, and 2 mf. were connected in parallel. Under

the tube socket of rectifier tube G1, an insulating plate was placed and at the same time fastened by the screws of the socket; to prevent a chance contact of the prongs of the rectifier tubes with the metal coating of the plywood plate.

After the mounting of the parts on the baseboard, all the parts were wired so far as possible before putting on the side walls. The side wall and back wall of the power section are made of a single piece of sheet aluminum 0.12-inch thick, which is screwed to the front plate by a bent flange (Fig. 2). On the left side wall are the six terminal screws already mentioned, for the voltage taps provided by the transformer. Since they lie fairly close to the baseboard, a strip of insulating material was laid along the left hand edge of the latter, over the copper foil; so that no contact of the terminal with the copper is possible. The heater

resistors—R6 on the left side wall and R7 on the front panel—are to be insulated carefully. For the purpose there was put on the inner side an insulating plate, whose hole is equal to the diameter of the shaft to pass through. The hole in the metal wall is on the other hand kept about 1/10 inch larger. On the outer side, below the nut which serves for fastening the resistor, is a smaller insulating plate, whose hole corresponds to the diameter of the shaft of the resistance.

On the right side wall a lug L6, put under one of the fastening screws of the condenser C16, serves for grounding the latter. The cases of the condensers are grounded by their mounting on the metal wall. The radio-frequency chokes HF4 and HF5, mounted on a common, round hard-wood form, are fastened to the side wall by two screws. Also we find here a

(Continued on page 356)

CIRCUIT of New PILOT ALL WAVE RECEIVER

THERE is no comparison between this set and the tuned-radio-frequency receivers heretofore employed for short-wave reception. American broadcasting stations on the 49-meter band are heard with the same fineness of tone and clarity of reception that characterizes the regular Pilot-midget on the 200-550 meter range. Chelmsford, Paris, Rome, Sydney, and other foreign stations have been and are being received in New York with power and clarity that a year ago we

Further details and discussion of the merits of this popular short and long wave receiver.

tion is turned on, the tuning control on the broadcast section set to approximately 550 kc., the wavelength indicator set to the desired range and the tuning knob operated as usual. The small knob at the left marked "Antenna Tuner" acts as a

broadcasting on that frequency, the broadcast section tuning control can be set either slightly above or slightly below 550 without impairing the sensitivity of the set. This should be done because the broadcast section is so sensitive that there may be some direct pick-up that will cause interference with short wave reception.

The second intermediate frequency is that of the standard broadcast section, 175 kc. This means that the oscillator in

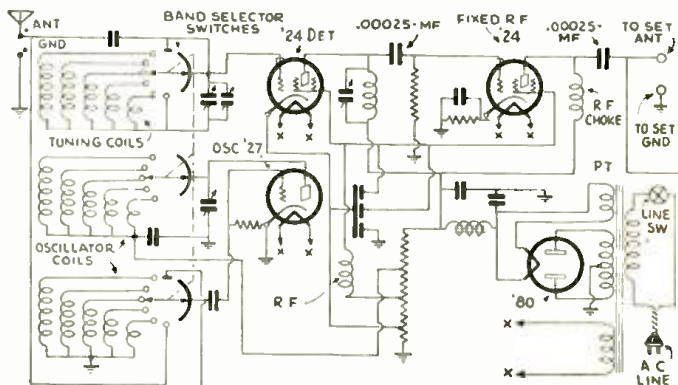
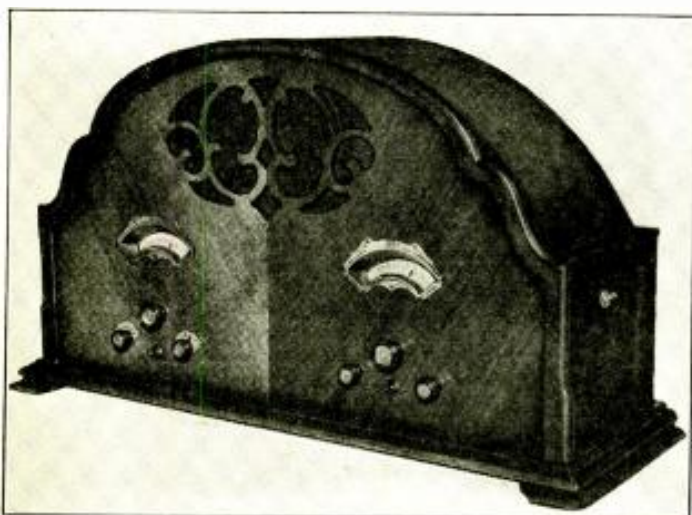

Above: Hook-up of Pilot short wave "converter," which tunes in S-W's when connected to "broadcast" receiver. Note that wire joining lower ends of tuning coils should be "grounded". With gang switch in 6th position, aerial is connected direct to broadcast set; also detector grid is "grounded".

Right: The latest Pilot "all-wave" receiver—2 dials, one for short and one for broadcast tuning.

would have deemed impossible. The only limit to the set's sensitivity below 200 meters is the noise level in the vicinity of the receiver. The selectivity of the "super" shows to excellent advantage on short waves and allows split-hair tuning between stations 10 kc. apart.

Volume control is exercised for both the short wave and the 200-550 meter ranges by the regular volume control on the midget super. The tone-control knob on the broadcast section allows progressive attenuation of the higher audio frequencies and is of considerable help in reducing noise when fishing for distant stations.

Easy to Tune

The set itself is very simple to tune and entirely eliminates the breathless manipulation so necessary with the old T.R.F. sets. As seen from the accompanying photograph, there are two sections, each with a clear vision tuning dial, two auxiliary knobs, and a switch. For broadcast operation the switch on the left side of the cabinet is turned on, the wave-changer on the short-wave section set to the "BC" position, the switch on the face of the cabinet put in either the "local" or "distance" position, depending on the station to be received, and the tone control, volume control, and tuning control operated as usual. For reception on wavelengths under 200 meters, the switch on the short-wave sec-

vernier on the tuning control and is the final adjustment after a station has been tuned in with the main tuning control.

Circuit Details

For each wave band the plate and grid coils of the oscillator and the detector grid coil are all wound on the same form. The spacing between the coils decides the value of induced voltage that the detector grid receives from the oscillator. Generally speaking, the higher the induced voltage from the oscillator the greater the sensitivity of the receiver. There are, however, certain limitations to be considered. Of these the reaction of one circuit on the circuit coupled to it is the most important, so that the spacing becomes a compromise between the highest induced voltage and minimum reaction. The coil forms themselves are so located around the wave-changing switch that the effect of any one coil upon any one other coil is negligible. In the knife-blade switch contact is absolutely positive and is more satisfactory and reliable than that afforded by plug-in coil arrangements. There are five contacts on each of the three switch sections. As seen from the schematic diagram, the detector grid, the oscillator plate and the oscillator grid are the points that are switched.

The first intermediate frequency is 550 kc. This value, however, is not critical and, if there is a strong local station

the broadcast section will be operating at approximately 550 plus 175 kc., or 725 kc. It is impossible to shield this oscillator absolutely and its harmonics will therefore be picked up by the short-wave section. The third harmonic, for example, is 2175 kc., which is slightly under 150 meters. At about the middle of the fifth band, therefore, the short-wave section will appear to have tuned in on a very strong carrier that will have no modulation. These harmonics are not annoying and the operator will quickly become accustomed to them.

There is not much going on in the way of phone broadcasts on the lower part of the first band. The transatlantic telephone services use various waves in this section but speech is purposely scrambled and cannot be understood. Scrambled speech can be recognized by the peculiar shrill sound that squeaks forth every few seconds. Occasionally the phone stations will test without scrambling. The London end has been heard frequently and comes in as loud as the American transmitter. Between 70 and 80 on the dial there are a few continental phones that can be heard in the morning and early afternoon.

The second band is very much alive with code and phone stations. Between 60 and 95 there are many stations, such as FYA in Paris and G5SW in England. These stations come in quite loudly and

(Continued on page 351)

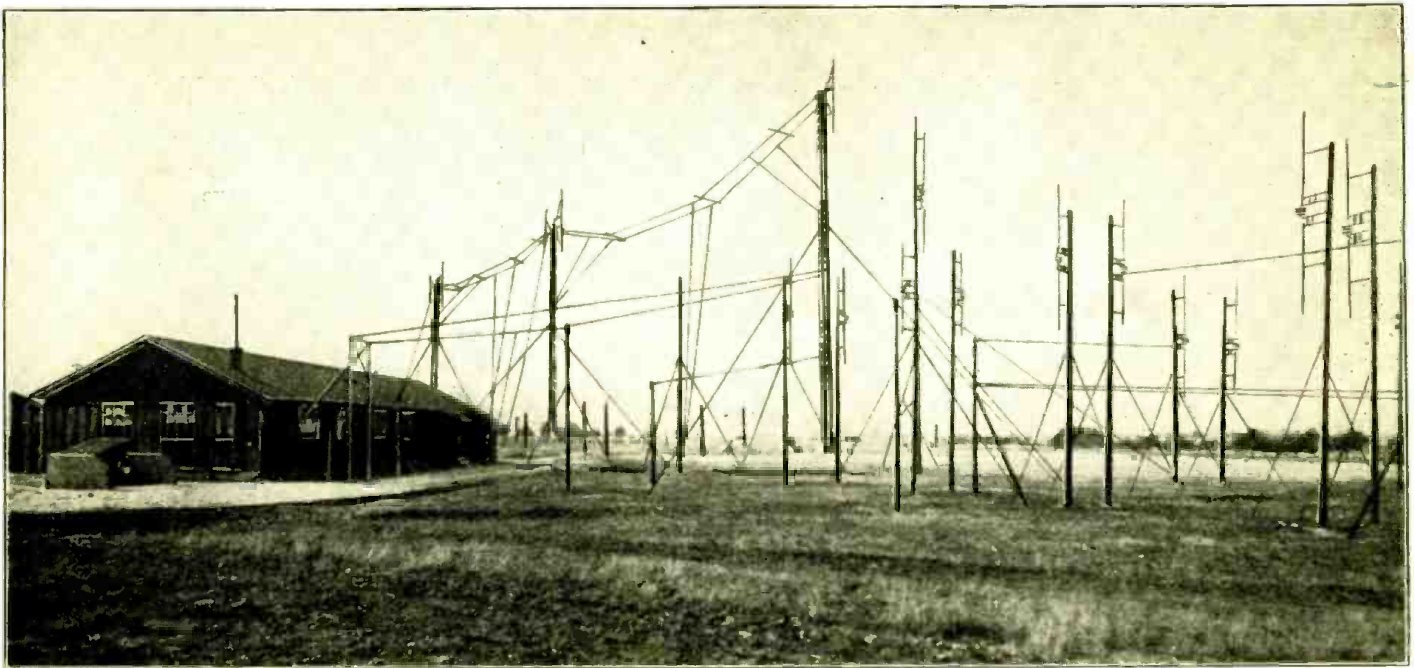

The Radio Field Laboratory at Trappes, near Paris, France, showing antenna and transmission building.

SINGLE SIDE-BAND

TRANSMISSION ON SHORT WAVES

By C. H. W. NASON

A resume of what has been done with short wave, single side-band transmission and reception in actual tests.

If a carrier wave and a modulating speech component are intermixed in a Carson "Balanced Modulator," the carrier will be completely suppressed and only the sum- and difference-frequencies known as *sidebands* will be transmitted. By the use of suitable filter systems either sideband may then be suppressed and a considerably smaller band width will be occupied for transmission of the remaining sideband to the receiving point. Here it is necessary to re-supply the lost carrier before detection can be accomplished. Such a system has been used for many years to increase the number of messages which can be transmitted over a single-wire circuit.

In development of the transoceanic telephone channels, the engineers found that by means of single sideband transmissions, a gain of some nine "db" (decibels) in the ratio of signal-to-noise levels could be achieved for a given output power, where single-sideband transmissions were employed. Because of the fact that transmitting amplifiers of the balanced "Class B" type were employed, the single sideband system gave an added advantage in conservation of power; for, during the periods between speech im-

amplifier classifications will clarify this statement for the reader.

Single Sideband Transmissions at High Frequencies.

It is essential that the re-supplied carrier must not vary in frequency from that of the original carrier by more than 20 cycles, plus or minus, if speech quality is to remain acceptable. Such a demand is easily met in the case of wire-line carrier-current apparatus, such as employed in multiplex telephony, and is also readily obtained in transoceanic radio-telephony at the frequencies employed on the transatlantic links. As students of commercial short-wave work will probably know, the Madrid-Buenos Aires link operates at a wavelength of 15 meters or 20,000 k.c.; at which frequency the required stability would be of the order of one part in a million. Such excellence in oscillator design is possible in the laboratory, but not under the rigorous conditions of the field.

The answer has been found in the transmission of a "pilot" wave, either of the same frequency as the suppressed carrier, or at some other frequency close to the range covered by the transmitted sideband; so that it does not appreciably broaden the width of the transmitted band. The system not only involves the control of the local oscillator at the receiver by means of this pilot wave, but the frequency of that oscillation must remain reasonably constant during such periods (as may occur) in which the controlling influence is obliterated by selec-

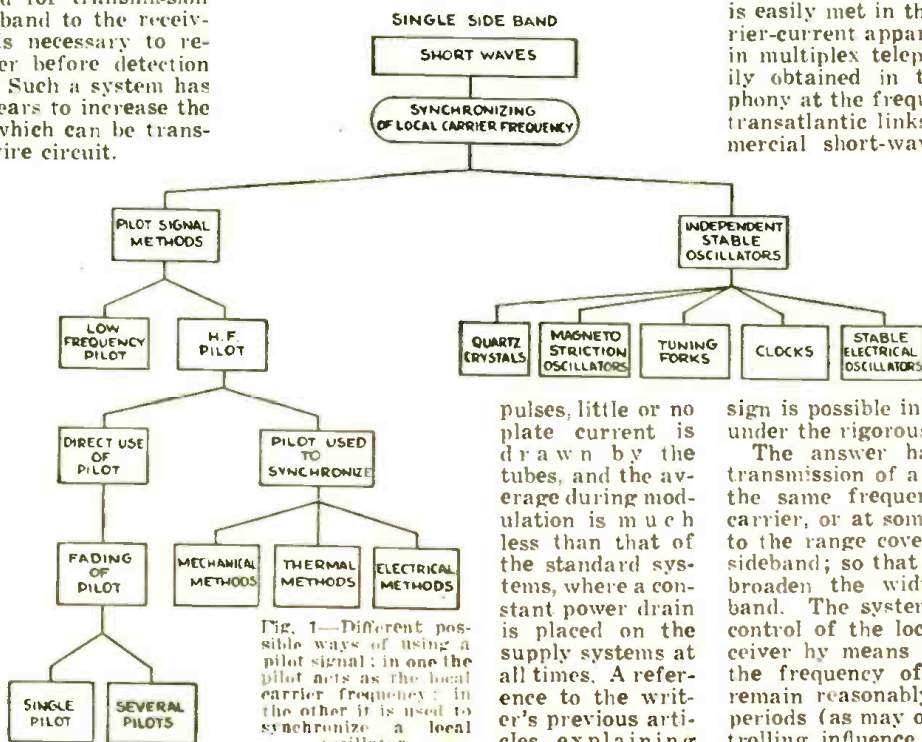

Fig. 1—Different possible ways of using a pilot signal: in one the pilot acts as the local carrier frequency; in the other it is used to synchronize a local oscillator.

pulses, little or no plate current is drawn by the tubes, and the average during modulation is much less than that of the standard systems, where a constant power drain is placed on the supply systems at all times. A reference to the writer's previous articles explaining

tive fading. The manner in which this controlling influence is transmitted is immaterial to the problem—it may be a portion of the original carrier by-passed around the suppressing modulators, or it may be a separate oscillation of high stability and of frequency so close to that of the components to be transmitted, that it will be amplified by the same circuits and propagated from the same antenna if so desired. The level of this pilot wave may be so far below that of the single-sideband components, that an inappreciable load will be placed upon the amplifier circuits by its presence.

The Frequency-Stabilizing System

In order to understand the operation of the new system, it might be well to state, at the outset, that the "pilot" signal itself does not act as the *re-supplied carrier*, although a satisfactory system of that character might be devised. The receiver used is a "triple-detection" affair (operating much after the fashion of a superheterodyne converter), in conjunction with a commercial broadcast superheterodyne. The single-sideband components are beat ("superimposed") against a series of oscillators; so that they eventually produce components of so low a frequency that the resupplied carrier is well within the frequency range required, for

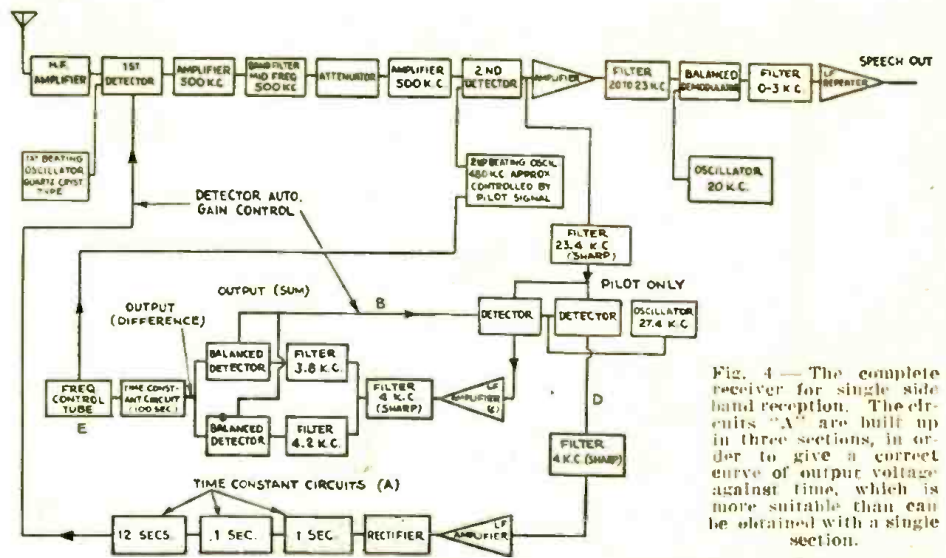

Fig. 4—The complete receiver for single side band reception. The circuits "A" are built up in three sections, in order to give a correct curve of output voltage against time, which is more suitable than can be obtained with a single section.

intermediate frequency separated by 500 kc. from the pilot signal. This device is made sufficiently broad to permit the passage of the single-sideband components, of the signal which has been shifted to a range close to 500 kc., by the action of the crystal-controlled oscillator.

3.8-ke., respectively. The resonance characteristics of these two circuits are such that, with the output of the amplifier "D" exactly at 4,000 cycles, an equal voltage will be induced in each; and equal voltages will be applied to the grids of the two rectifier tubes "G" and "H". The output circuits of these two rectifier tubes are so arranged that with the grid voltages equal, a balanced "bridge effect" will obtain. Should the frequency of the 504-ke., oscillator deviate from 504 kc, in either sense, this "bridge balance" will be disturbed; and the unbalance will result in a change in the grid bias of the tube "J". The plate resistance of this tube is in shunt with a coil—L2—loosely coupled to the oscillator tuning inductance—L1. Any change in the load or effective resistance of this coil will result in a minor change in its effective inductance, in such a sense as to tend to shift the frequency back to exactly 504 kc. (This may be proven mathematically.) This illustrates the principle of the frequency control effected by the use of the pilot signal. In order that the action should not be subject to impulsive changes or fluctuations across GH, a time constant of 100 seconds is introduced by the resistance R2 and the condenser K; these are respectively of the order of 5 megohms and 20 microfarads.

It is quite impossible, in practice, to achieve an accurate balance between the two tubes "G" and "H". That is to say, if the tubes are balanced for one level of input voltage, a fluctuation in the level of the "pilot" will shift the level of the 4,000-cycle component applied to the grids of these two tubes, and create a possible unbalance in the output circuits, due to the fact that the characteristic

(Continued on next page)

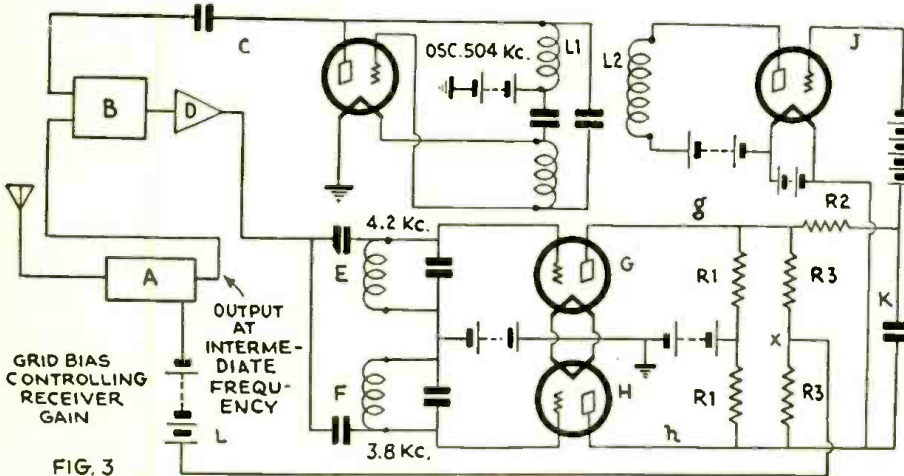
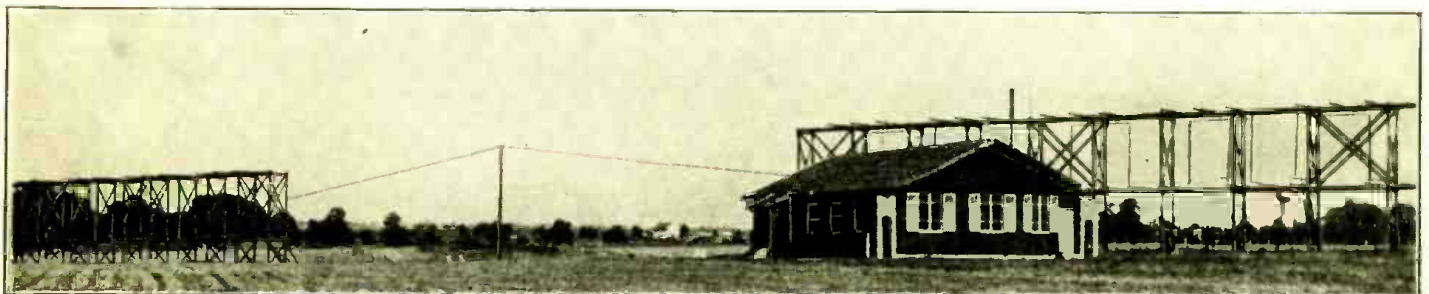

FIG. 3—Frequency changing circuit. "A" represents the high frequency amplifier, first beating oscillator, first detector and first intermediate amplifier of the receiving set.

the degree of frequency-stability required of the re-supplied carrier. How this change from the original frequency-range to that of lower order is made will be presently shown. The circuit arrangement showing the control effect of the "pilot" wave appears in Fig. 3.

The element "A" in diagram 3 represents a first detector and a crystal-controlled oscillator, such as to produce an

The 500 kc. output is applied to a rectifier "B", together with a small portion of the output of a 504-ke. oscillator "C". The output of the rectifier (representing the difference between the 500- and 504-ke., oscillators) is passed through an amplifier "D", which is tuned closely to 4,000 cycles, and has its output so coupled as to feed directly into the two circuits "E" and "F", which are tuned to



Radio Field Laboratory at Trappes, France, showing antenna and reception building.

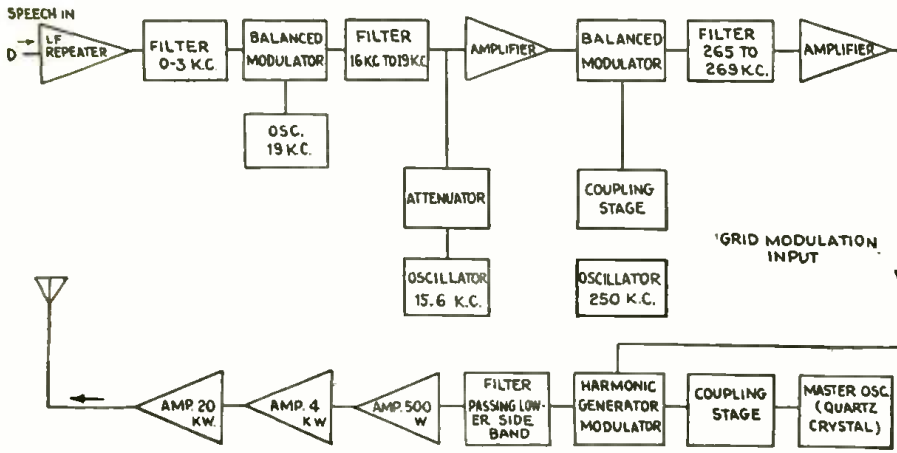

Fig. 5—Schematic diagram of single sideband transmitter used in experiments here described.

Fig. 2—Method used for changing oscillator frequency: variation of resistance changes total effective inductance.

curves of the two tubes will not coincide throughout their full range.

For this reason, if a change in level occurs in the "pilot" wave, a tendency to shift the frequency of the oscillator will result. It is only necessary that a circuit arrangement, such as to change the bias on the first I.F. amplifier tubes with changing amplitude of the "pilot" be introduced, to automatically control the gain of the intermediate frequency (500-kc.) stages. To effect this, the resistors R3 are added and their midpoint "X" will be at a potential average between that of *g* and that of *h*. The voltage of "X" will be dependent almost entirely upon the level of the 4,000-cycle component, and not upon its frequency. This potential is additive or subtractive, in its relation to the fixed bias on the amplifier tubes, as the case may be.

This circuit arrangement does not differ materially from the usual gain-control circuit employed in other commercial

superheterodyne receivers. The time-constant of this gain-control circuit is made short enough to have the control active for even the shortest period in which fading is likely to be encountered. The time-constant of the frequency-control circuit, also, is sufficiently long to maintain the frequency of the 504 kc. oscillator constant even over the longest periods of fading likely to be encountered.

The Complete Receiver

The skeletonized circuit of the complete receiver appears in Fig. 4. It is essentially a triple-detection receiver, in which the first oscillator is crystal-controlled

and produces an intermediate frequency of the order of 500 kc. The second oscillator is automatically controlled as to frequency, and serves to produce an intermediate frequency of the order of 20,000 cycles. The band-pass filters in the 500-kc. system are broad enough to pass the single-sideband and the pilot-wave components of the 500-kc. (or thereabouts) signal. Those in the 20-kc. circuits are so sharp as to pass only the 3,000-cycles band necessary for the transmission of the single sideband representing the speech modulation. The high degree of selectivity necessary for the receiver as a whole is procured in this 20-kc. circuit.

The next problem in importance is that of fading—which may be of the synchronous or selective types. Selective fading is that whereby a single frequency

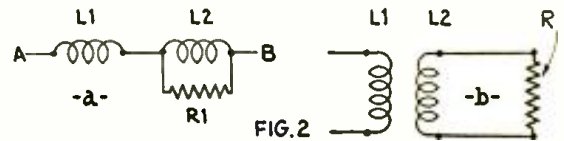

is affected; and in normal transmissions selective fading of the carrier frequency results in a severe distortion, due to the apparent change in the percentage modulation resulting. The freedom of single-sideband systems from this type of fading is one of their greatest advantages. Synchronous fading may be counteracted by the use of automatic gain controls, for here all components are affected at the same time and in the same degree. Fading of the pilot wave, either synchronous or selective, is controlled in the manner already described.

(Continued on page 360)

Antennas for Ultra Short Wave Transmitters

By HARRY D. HOOTON,
W8BKV

ONE of the most important things connected with ultra-short wave work is the antenna system for the transmitter. The installation of the ultra short-wave antenna requires the utmost care in design and construction. Almost any of the plain antennas will function at extremely high frequencies but, since the directive an-

tenna system is more desirable for this work, the following pages will be devoted entirely to a discussion of this type of antenna in its simpler forms.

The length of the ultra-short wave antenna is determined in exactly the same manner as when the antenna is being designed for the longer waves of, say, twenty or forty meters. First, decide in which part of the band the transmitter will operate—the upper or lower edges or near the center. Suppose the desired frequency is 60,000 kilocycles and the antenna is being designed for it. To find the radiator's length in feet we multiply 300,000 by 1.56 and divide the product by 60,000. To make it still simpler, the figure into which you divide the frequency of the desired radiator will in every case be 300,000 times 1.56 or 468,000. For instance, 468,000 divided by 60,000 is 7.8 feet or about 7 feet 9 inches—the correct length of a five-meter, half-wave antenna.

The second step is the design and the construction of the reflector. This may consist of several wires, of one-half wavelength each, supported vertically along a horizontal parabola; the main antenna being at the focus. It may also be a simple single-wire reflector type, as

shown in Fig. 2 at "a". Several of these single-wire reflector antennas are often arranged as shown in Fig. 3 at *a* when a highly directive system is desired. A three-wire reflector systems (Fig. 2 *b*) has been used considerably by the writer in 3/4- and 5-meter work. The spacing between the reflectors and the radiator, and between the reflectors themselves,

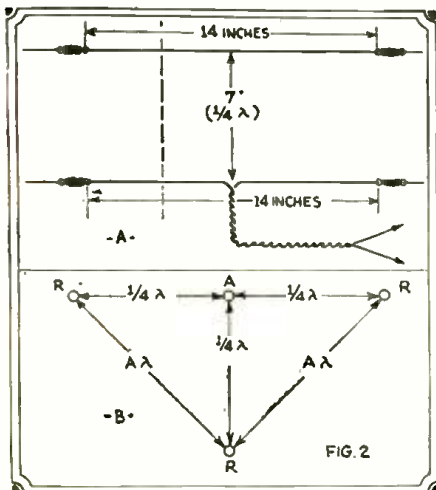

Fig. 2, shows direction of transmission, which is downward for the U.S.W. antenna illustrated at A. A three-wire reflector system as used by the writer for 3/4 and 5 meter work is shown at B.

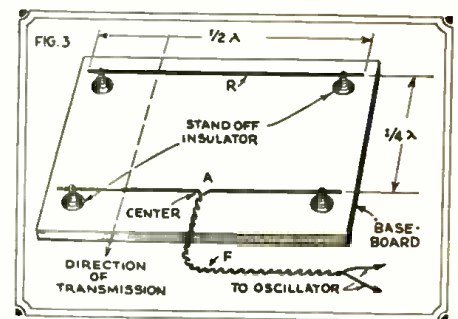

Fig. 1, above, shows an ultra short wave antenna at A and reflector at R, the dotted arrow showing the direction of transmission.

must be carefully adjusted if the antenna is to be efficient.

There are several methods of spacing the reflectors in the directive antenna system. The most popular method is to

(Continued on page 361)

Hints on A.C.O. operation OF S-W RECEIVERS

By "BOB" HERTZBERG

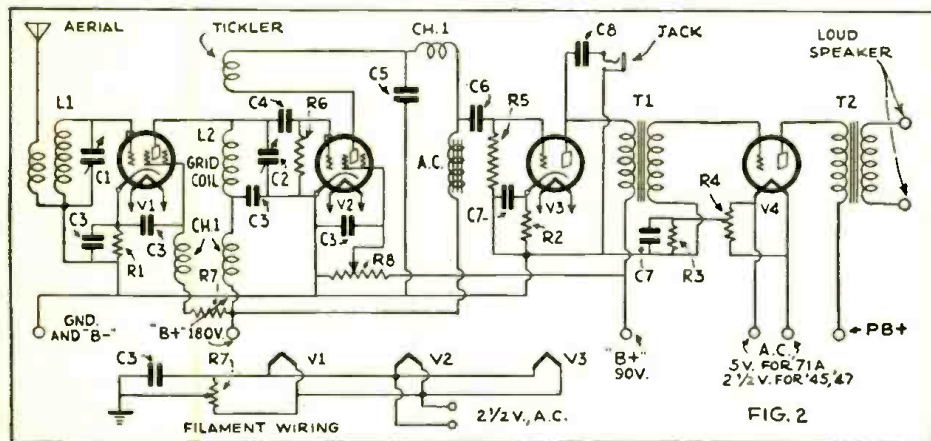

There are many tricks worth knowing in operating S-W receivers on 110 volt, 60 cycle A.C. lighting circuits. Mr. Hertzberg discusses the source of "tunable" hums and other noises that frequently mystify the short wave beginner.

ANY radio experimenter who attempts to "electrify" a battery-type short-wave receiver, according to the same general principles he has successfully followed with broadcast sets, quickly learns that the same tricks (usually) don't work. The tubes light, the voltages are correct and the loud speaker produces signals; but invariably overwhelming everything is a loud, disagreeable hum. To make matters more mysterious, this hum is decidedly worse on certain wavelengths than on others; in fact, it displays all the characteristics of a "legitimate" radio signal.

"Tunable" Hums—Their Source

"Tunable" hums were long the bugbear of radio engineers seeking to perfect a marketable A.C. short-wave receiver. Their main source was found in the power pack, which seems to be a prolific generator of radio-frequency energy, as well as of raw A.C. for filament lighting and smooth D.C., for plate supply. From the standpoint of the set manufacturer, the problem was overcome by the design of special power packs fitted to the peculiar requirements of particular kinds of sets.

There are undoubtedly many owners of battery-type receivers who would like to revamp their outfits so that they can enjoy the superior electrical characteristics of A.C. tubes and the undeniable conveniences of A.C. operation. They can readily apply the expedients devised by laboratory workers, making use of simple and inexpensive parts they can find in their junk boxes.

Power Transformer—Special Shield

Really, the most desirable piece of apparatus for the short-wave power pack is a power transformer having an electrostatic shield between the primary and secondary windings. Such transformers are not widely available as separate units, but probably will be so in another few months. Meanwhile, standard trans-

formers, of the kind that can be bought for only a few dollars, can be made to work satisfactorily.

Much of the racket that comes from the loud speaker of an A.C. short-wave receiver is due to stray R.F. disturbances picked up by the power line. An electrostatic shield in the transformer effectively keeps these out of the rectifier system; but, with an ordinary transformer, considerable protection can be obtained from two good "non-inductive" condensers connected as shown in Fig. 1. These condensers, marked C1, may be 0.1-mf., or any size smaller, down to about 0.006-mf. Note how they are connected in series across the line, with the center leads grounded. It would be highly desirable to use an R.F. choke in each leg of the 110-volt A.C. circuit, but no ordinary choke is at all suitable for the purpose. It must have a low resistance, which means heavy wire and, therefore, a large and unwieldy form. The condensers alone are a big help, and are well worth trying.

The High Voltage Rectifier

In the high-voltage rectifier circuit, which carries only a low current, a standard receiver-type R.F. choke coil should be inserted in the positive leg, between the rectifier tube's filament and the first sections of the filter system. This helps to keep the D.C. output clear of any loose R.F. current set up by the '80 rectifier. This R.F. current is further discouraged by a pair of fixed condensers connected across the high-voltage secondary. These condensers, marked C2 in Fig. 1, will be recognized by oldtimers as the "buffer" condensers employed so widely a few years ago when the Raytheon or gaseous-type rectifier tube was popular. They should be about 0.1-mf., and of the non-inductive type.

The rest of the power pack is of standard construction, consisting of two filter chokes, a three-section filter condenser, and a voltage-divider resistor.

Doctoring the Filament Circuit

Getting into the receiver itself, we now find little to do except to take care of the filament wiring. Refer to Fig. 2, which shows the hook-up of a typical screen-grid receiver; and see that a center-tap resistor, R7, of 20 ohms, is connected across the 2.5-volt line, with its center-tap grounded, and with a mica fixed condenser, C3 of .01-mf., bridged across one section. In many A.C. sets it has been found that the inductance of such center-tapped resistors, combined with the stray capacity of the associated wiring, is sufficient to form a closed oscillatory circuit that is shocked into continual oscillation by the heavy A.C. flowing through the leads. These oscillations usually fall somewhere inside the wide tuning range of most short-wave receivers; and they are picked up and reproduced by a sensitive set, just as if they were regular radio impulses. Of course, the oscillations bear the modulation of the 60-cycle exciting current, and therefore come through as loud hums.

David Grimes and other engineers have demonstrated that oscillations created by this action can be raised in wavelength by the mere insertion of loading condensers; C3 accomplishes this purpose. Its capacity is so high (relatively) that it tunes the little local oscillator to a wavelength beyond the range of the set.

Not all sets have tunable hums of this kind. The mechanical arrangement of the parts and the method of wiring have a great deal to do with the effect.

Chokes and By-Pass Condensers

Proper choking and by-passing is important in any receiver, but particularly so in an A.C. set. Inadequate protection brings about inter-circuit coupling which is likely to ruin the entire receiver. Fig. 2 shows a complete four-tube layout which can well be followed by anyone wanting a first-class short-wave outfit.

The first tube, V1, preferably a variable-mu '35, is a T.R.F. amplifier, with its grid circuit coupled to the antenna

(Continued on page 359)

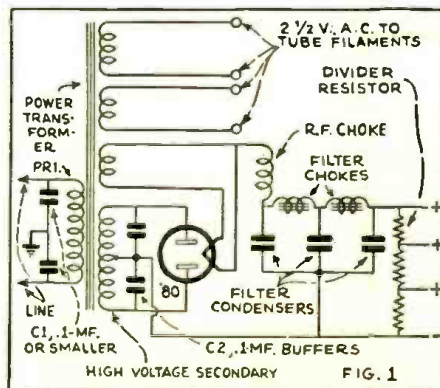

The "how and why" of the A.C. power supply unit is discussed by "Bob" at length.

The INTERNATIONAL ALL-WAVE DUO RECEIVER



Two-dial "dual" receiver, tunes from 20 to 600 meters; without "plug-in" coils.

THE International All-Wave Duo is a long and short wave receiver built in one complete chassis. There are two illuminated tuning dials, one for short waves, which will receive from 20 to 200 meters—the other for long waves, from 200 to 600 meters. One tone control which operates for both short and long wave reception; one switch for changing from long to short wave reception. There are no "plug-in" coils to change. Short wave coils are wound on a drum type selector which operates from a knob on the front of the panel.

There are three positions on the short wave band—No. 1, 20 to 75 meters; No. 2, 75 to 125 meters; No. 3, 125 to 200 meters.

The Duo is an eight-tube "super" hot chassis; the tube equipment consists of: 2—235 Variable Mu; 3—224 Screen Grid; 1—227 Oscillator; 1—247 Pentode (output); 1—280 Rectifier.

Simple Operation—The A.C. Switch is combined with the volume control, which controls the volume for both short and long wave bands. After set has been turned on, you can switch from short to long waves instantly, or back to short waves again, by turning the lower left hand knob.

Many transcontinental short wave stations can be logged accurately. For example—set the long wave dial at 95 and

Chelmsford, England; 13RO Rome, Italy; W9XF Chicago, Ills.

The Duo short wave receiver operates with oscillation under control at all times. You can hear the carrier waves on the short wave stations, without the "whistling sound". In other words, the Duo tunes in short wave stations the same as a regular long wave distant station on any standard set; you only hear the voice or music.

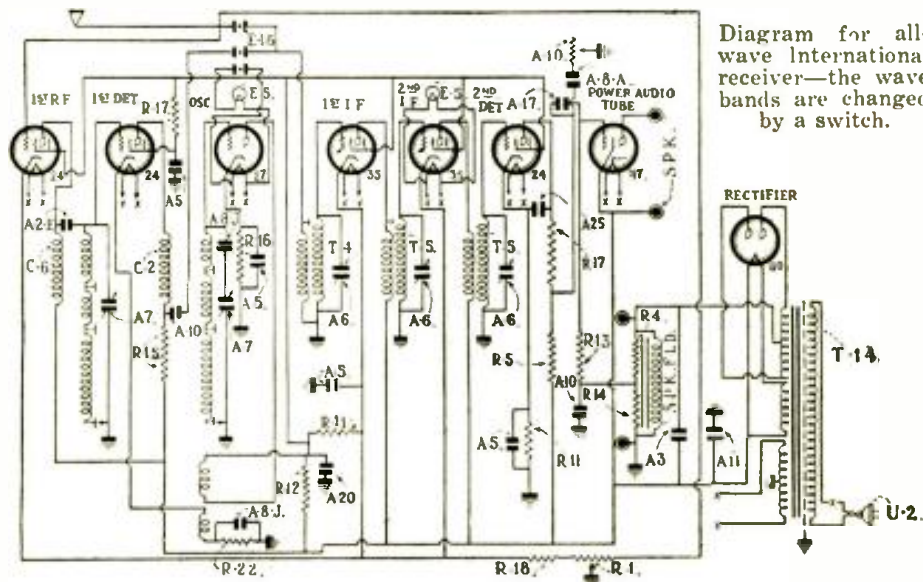

Diagram for all-wave International receiver—the wave bands are changed by a switch.

the short wave band selector at No. 1 and adjust the short wave dial between 50 and 60 degrees on the dial. Several European short wave stations operate on this 25 meter band such as G5SW

The International All-Wave Duo can be obtained in a mantel type cabinet or chassis only for export. 110-220 A.C. voltage transformer which operates on 50 to 60 cycle current is furnished as standard equipment.

New Tobe Deutschmann Oil Condenser

The accompanying picture shows one of the new Tobe Deutschmann high voltage, oil-impregnated, oil-filled, tank constructed condensers, which carry a two-year replacement guarantee. This new line of condensers are designed and built

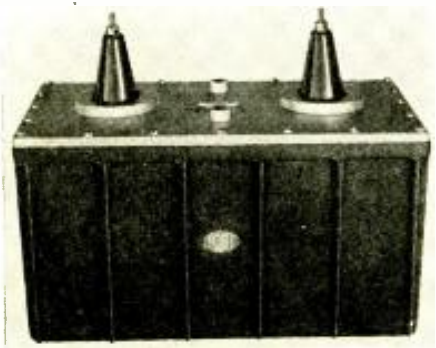

A new, oil-filled, transmitting condenser.

to operate on potentials of 3,500 to 15,000 volts continuously. The internal parts of the condenser are made with extreme care and rigidly tested both before and after assembly.

According to the manufacturers they have been especially designed to stand up under the most severe operating conditions and under continuous duty when necessary. This fact will be readily appreciated by amateur and commercial broadcasting stations, tube and apparatus manufacturers, and particularly operators of the better-class amateur transmitting stations.

Dubilier High Voltage Condensers

The well-known Dubilier line of high voltage radio condensers have recently been redesigned and due to improved production methods, the price on the Dubilier line has been markedly reduced, without sacrificing the more than liberal safety factor and long life, for which these condensers are known. The new low price on the Dubilier high voltage

condensers cover the following types: 686-A, 689-A, 688-A and 690-A, of 1,000, 1,500, 2,000 and 3,000 volts, and 1 to 4 mfd. capacity.



Dry type, high tension condenser of improved design.

Interesting Experiments WITH the OSCILLOGRAPH

At some time or other, nearly every experimenter has wanted to own an oscillograph. For the benefit of those who are not familiar with this apparatus, a short description of its use will be given.

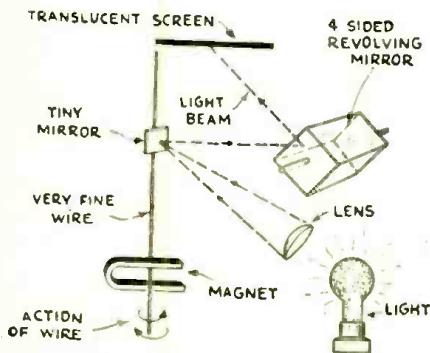

Fig. 1, above, shows the principal parts of the Duddell type oscillograph, the double wire loop twisting one way or the other, depending upon the form and degree of current passed through it. The wave pattern is reflected on to the screen by the mirrors.

Perhaps the most common use of an oscillograph is to obtain pictures or the variations of current flowing in a circuit. If it is desired to know the shape of the current, or whether it has the sine-wave form, an oscillogram will readily show any deviation from the sine-wave shape and any ripples which happen to be present. It can be used for checking the ripple present in "A" or "B" eliminators, or any other rectifying device. By impressing a sine-wave shape on the input of a power amplifier, it will show any harmonics or distortion occurring on the output. In fact the uses of an oscillograph are almost numberless; and, after using one for a time, many other possibilities will suggest themselves to the experimenter.

The common form of low-frequency oscillograph called the "Duddell" type is somewhat complicated. It consists essentially of a very fine copper wire, bent into a loop shape and suspended in a strong magnetic field. Across the wire is fastened a tiny piece of mirror which vibrates with the wire, at a frequency depending on the frequency of the current passing through the wire. A very small beam of light is focussed on the mirror and is reflected to a revolving four-sided mirror. The reflection is again passed on to a plate, from which it can be viewed or photographed. Fig. 1 shows the principle of the Duddell type.

By JESS M. REED

Some simple experiments are described in this article which will interest radio amateurs as they can be conducted with parts to be found about the home "lab."

As current is passed through the wire, the wire is forced to turn by the reaction of the fields of the wire and the magnet. The greater the amplitude of the current, the farther the wire will turn and, as the mirror is fastened to the wire, the greater will be the arc covered by the beam of light reflected by the mirror. The spacing of the waves is controlled by the speed of the revolving mirror. It is obvious that in this type, at higher frequencies, the resulting oscillogram cannot be absolutely accurate; because of the inertia of the moving parts, mostly the mirror on the wire. There is considerable damping effect by windage, which also tends to slow down the action. Thus any small ripples in the current will not show up as prominent as they really are. The inertia and windage limit the frequency response of this type, which is accurate up to a frequency of about one thousand cycles per second.

The oscillograph to be described here is one devised by the writer which, although not as sensitive in its present form as some commercial types, has the advantage of cheapness of construction, no revolving mirrors, no delicately-adjusted beam of light and no mirror to be attached to a wire; thus eliminating the greatest part of the windage and inertia. It can be built by anyone having a small motor. It consists essentially of a cardboard disc having slots cut at intervals around the edge, a motor to turn the disc, a piece of fine wire, a magnet and a light. A diagram is shown (Fig. 2)

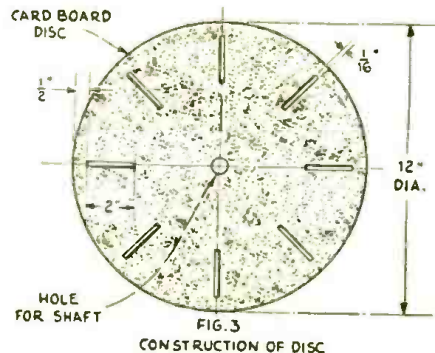

Fig. 3, above, shows how to lay out and construct the disc for the oscillograph here described.

of the arrangement of the apparatus.

The disc should be about 12 inches in diameter, or larger. Eight slots are cut in the disc, equally spaced around the

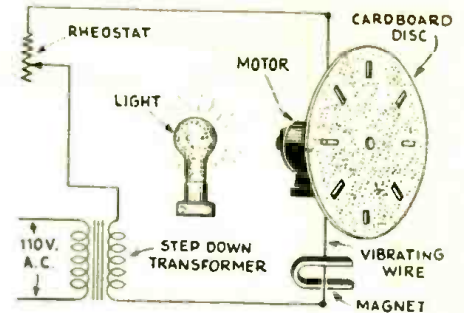

Fig. 2 shows stroboscopic arrangement devised by the author for observing oscillographic figures by means of a revolving slotted disc, which is placed in front of a vibrating wire. The motor is not connected to the vertical wire passing through the magnet, although it might appear to do so.

circumference; and a hole is cut in the center to fit the disc to the shaft of the motor. The wire is placed behind the disc so that it can be seen through the slots against the light. The light bulb should be of the frosted variety; or else a piece of frosted glass should be placed between the bulb and the wire to give a more equal distribution of light.

A strong magnet is placed around the wire, as shown, to make the wire vibrate when current is flowing. The wire should be bare or enameled, about gauge 32. Audio transformer wire is good for this purpose.

Try vibrating a rubber band in back of the disc to see the effect; it will show up as ripples. The slots in the disc should be about 1/16-inch wide; the greater the number of slots, the slower the disc has to be turned for a certain frequency and the closer the ripples will be. If the disc is turned too fast, no picture will be obtained; if it is turned too slow, a picture will be obtained, but the ripples will be close together. The speed is not critical at all. In fact, the effect can be seen by slowly turning the disc by hand.

Fig. 3 shows the construction of the disc. The slots should be cut with a razor blade or a good sharp knife, in order to have clean edges on them and give a clear picture. The disc should be turned very slowly for sixty-cycle current. Either a variable resistance or a light bulb can be used in series with the motor to reduce its speed.



Dr. Willis R. Whitney, famous scientist of the General Electric Co.

EVERY chemist knows that, in general, rates of chemical processes rise between two- and three-fold for each ten degrees Centigrade rise of temperature; and this might mean a possible very appreciable gain in mass for that part of the growing plant which was heated above its environment. So I thought that if I could put the hot greenhouse inside the plant, instead of the reverse, I might grow a tumor there.

In the very high-frequency radio field, we had a device for heating certain types of resistance at remote distances. A whole plant could be warmed internally by submitting it to the electromagnetic field, but the degree of heating varies also with the nature of the thing to be heated. I realized that an insect's egg or larva could not be easily imitated; but I found that a very minute piece of steel, the tip of a very fine needle, could be inductively warmed enough to melt its way slowly through wax, even when the power was low and the coils or antenna were at some distance. So I concluded that this heat or power could not injure the plant. The tiny needle points (my warm eggs) I inserted into the stems of young, potted goldenrods, and applied the radio energy for a summer; and then repeated it the next summer. But, except for a gall which grew on one of the plants from an egg which, without my knowledge, was already in the stem, I never succeeded in producing a plant tumor. I haven't given it up, but I have learned a lot about plants without learning how they do determine new growth. Probably they, like the trees, grow only in a sort of shell surrounding their past growth, the cambium about the idle wood. The little gall fly knows better where to put her eggs than I do. My steel eggs either remained dormant just where I put them (while the stem placidly extended above them) or, when I had put the needle-point right into the growing tip, it was

How Research and Industry Depend on Vibrations

By DR. WILLIS R. WHITNEY

Director, Research Laboratory, General Electric Company

(Concluded from Oct.-Nov. issue)

later found at the top of some young leaf. I could not grow a tumor. And I could not give up. It seemed certain that extra heat inside a plant should speed up local growth; just as putting a whole plant in a warm place forces all the parts.

So, though it may be foolish to admit it, I have tried again this spring, with the same idea applied to growing onions and to small trees, but without getting the particular narrow-minded result I sought. We did learn, incidentally, as often happens, that it was easy to kill the grub in the galls by application of the radio energy; and we knew that it was due to the grubs being overheated internally.

This led to experiments on fruit flies, because they are the test-tubes of the biologist. We found that, when ice-cold air was blown through a tube of these flies they immediately hibernated and seemed dead. If, now, we applied the

Dr. Whitney gives us something to think about: Tomorrow every man will be his own "furnace"—thanks to high frequency (short wave) currents, and these same currents, about which we know but little as yet, will undoubtedly cure the thousand and one ills that human flesh is heir to.

radio field while the air and all the surroundings were still at ice temperature, the flies became lively and flew about, and with a little more external radio energy they would die from internal overheating. This was destructive, but not productive.

Discovery of Radio Fever

Such experiments led to others on rats and dogs, for here we could measure the induced temperatures and follow the effects. At about this time, some of the engineers thought they felt the energy in their bodies, their knees heated when near a large generator, and this was investigated. It was found that a man near a large outfit of unusually short wavelengths rose in blood temperature a degree or more.

In our experiments we had first made imitation animals out of gelatine. Instead of sweetening our jellies, we used common salts and studied those concentrations corresponding to animal blood. In this way we found that the heating effect varied with the salt concentration, and that, with any particular concentration like normal blood, we got the quickest heating when a certain wave-

length (number approximately ten thousand trillion) was used. Later we learned that, given such data as conductivity and dimensions, it is possible to calculate what electrical hookup will best serve a given purpose.

It was not at all clear, even when we knew that the heating took place within the body fluids, that it was harmless; and for that reason our jelly rats were followed by real rats. The early work with little numbers like ten thousand, (or X-rays) had shown one of the most remarkable known biological effects, and we had repeated it on insects. Rays in the range ten to one hundred thousand do something destructive to living matter which may not disclose itself for years; but, by increasing the dose, the effects may be brought out quickly. So with X-rays, we had treated fruit flies in lots of a hundred to different doses while they were in closed wooden boxes, and we found that, while homeopathic doses did no harm, larger doses insured a regular subsequent time for death, an exact death-expectancy. For example, after a certain dose, the flies would live for ten days, but die in twelve. Two half doses were equal to one full dose, etc.

We found no such effect with number ten thousand trillion, however. We found, instead, that rats liked a certain amount of this radio heat. So we made a long glass house, in one end of which the radio field could warm the rat with-

Tomorrow we shall probably never swallow a pill or a dose of medicine; instead our ailments will be treated by high frequency currents.

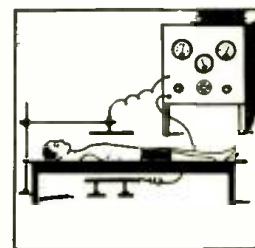

out heating the house, and in another part there was an ice-cooled box. Thus the rats could choose their preferred temperature. They soon moved their cotton bed into the electromagnetic field. Then we gradually, from day to day, increased the intensity of the field, so they became warmer and warmer.

Every Man His Own Furnace

No one knows how far we might have gone; but one day one of the rats came hurriedly out of his warm bed leaving his tail in the cotton. The tail proved to be entirely dried out. The rat was un-

(Continued on page 359)

AMONG THE "HAMS"

NO "PIPE DREAM" CIRCUITS

Editor, SHORT WAVE CRAFT:

May a "rookie" short wave enthusiast write to your column? I have been pleased with your magazine because it has just enough variety of theory and practicability to be "spicy". I have tried some of the circuit hints and found them satisfactory. No "pipe dream" circuits so far.

I have built the code practice set in the Feb.-March issue and found it will work with a 201A tube with a 4½ volt "C" battery, quite well. Have others done this, too?

In the Dec.-Jan. issue, mentioning the Short Wave Craft Box", I have successfully used a carborundum detector cartridge as a r.f. choke. No "dead spots" and it was not polarized like home-wound chokes.

Short waves have a peculiar habit of not being heard very successfully in these parts. Once in a great while a DX will pop in where "locals fear to tread". Chicago is hard to get, though I am only 80 miles from there. New York and Bowmanville, Ont., come in very well, but not strong enough to wake the neighbors.

A recent verification card from IIRB says that they broadcast daily from 6 to 11 P.M., C.S.T., and a special band concert on Thursday and Sunday from 7:30 P.M. till 8:45 P.M. They say they broadcast on 1370-ke. and 6005-k., although I get them on 6170-ke. On Saturday nights, I notice that they give the call of the "cou-coo" before announcing the call letters of the station.

Those who request verification cards from IIRB may address their letters to the City of the Vatican, but they will have to wait six weeks for an answer, but it is worth while for they get a post card photo of the Pope, Marconi and others before the microphone in the station. I got them one midnight, testing on their 50 meter wave length. A request for their schedule was not answered.

Tell Raymond Stephens of Davenport, Iowa, to give of his wisdom some of his secrets for reception of television on a one-tube set. Also tell WSCSY to give us the hook-up of the crystal set that will reach out 1,000 miles. I have often heard of long distance crystal "set", but yet to see one. It's hard to believe that it can be done. It would be interesting to try on the short waves.

Let us hear from foreign "hams", some of the laws of their country that govern them. Give us more articles by Joseph Noden, E. T. Somerset, etc.

Yours truly,
CHAS. H. RIGNIER,
Martinton, Ill.

(This is the sort of letter, Charles, that makes us feel good. Sometimes the editors receive certain circuits that they are not so sure about themselves, but as you know, it is manifestly impossible to test out each and every one, so we are glad to see that you find them all practical—"practical" being the middle name for SHORT WAVE CRAFT.—Editor.)

A "FLOP"

Editor, SHORT WAVE CRAFT:

I have just bought the April-May issue of SHORT WAVE CRAFT, and I want to congratulate you on such a fine magazine. I think it is the best source of information on amateur radio.

I am a builder of the "Sun Short Wave" tuner, published in your Aug.-Sept. issue, but I am sorry to say that it's a flop. I cannot get any stations below 85 meters. May be in the near future, you will print another circuit using Octo Coils. Also I would like to see in the near future a low-powered phone transmitter that can be built cheaply and also wish you would publish a list of "Q" signals in your magazine.

I am hoping to see this letter in your next issue.

In closing, I wish to say that I would like

Hats Off! to Homer Dunham! He Got His Man!

A radio tip relayed by Homer Dunham, W8DEH, "Ham" radio operator of Canton, Ohio, "brought home the bacon." Through the good work of Homer a murderer was apprehended and brought to time. The "Hams" are a valuable body of young men and the majesty of the law has had occasion more than once to say "thank you" to the "ham" fraternity. Keep up the good work, Homer.

to correspond with any "ham" of my age and troubles. I will answer all letters.

Yours truly,
ALBERT BATES
(Age 16),
3136 No. 27th St.,
Philadelphia, Penna.

(At last a man sized kick. Thanks a lot, Albert, for telling us that the Sun short wave tuner was a "flop." We took up the matter with the designers and here is what they say. "The wavelength to which any receiver circuit is tuned, is naturally dependent upon the number of turns of wire on the coils used, with a given size of tuning condenser. If you could not tune any lower than 85 meters it is apparent that you used the wrong coils, or else too large a condenser. If you carefully re-check your coils and condenser you will probably find that either one, or possibly both, of these parts of the set are of improper size."—Editor)

NOT SO GREEN

Editor, SHORT WAVE CRAFT:

With each issue of your magazine, SHORT WAVE CRAFT gets better and better. Incidentally I believe that I was instrumental in getting SHORT WAVE CRAFT on the newsstands in the "Border Cities". Prior to that time I had to get it in Detroit. Now I am told it enjoys a good circulation in these parts, which proves that your wonderful magazine is filling a much wanted need among the "Radio Fraternity"—old and new. If all of us do what we can to increase the circulation of SHORT WAVE CRAFT then we may get it monthly—here's hoping.

I cannot as yet pass along my Experimenters' Ideas, but here is a good idea—make a habit of re-reading SHORT WAVE CRAFT over and over again. You will be surprised what you can pick up in this way. Some small paragraph tucked away in a corner and containing just the very thing you have been wanting to know, may escape your attention the first time you read the magazine. I have benefited myself several times by re-reading the magazine; that is why I pass the idea along.

I think "WHEN TO LISTEN IN" by BOB HERTZBERG is invaluable data and I hope you will keep it up.

Just a word about my "Ham Activities". I built the "Junk Box" set and added to it a push-pull additional stage of amplification and also used a variable condenser (.00015 mf.) as an Antenna Trimmer, which assists in getting the most out of each coil and, of course, minimizes "dead spots". Regarding Grid Leaks I find that a value of 9 megohms gives splendid results if great care is given to manipulation of tuning condenser. A plentiful supply of different values of Grid Leaks is worth the outlay.



I use a first stage for phones and also loud-speaker stage. A potentiometer of say 100,000 ohms across secondary of first transformer makes a good volume control and eliminates "fringe howl". My set is very compact, it is built in a cabinet 9½" x 7" and 6" deep, batteries separate. Component parts are quite close together as you can well imagine, the condensers are mounted on an aluminum panel and I am not troubled with body capacity.

As yet I have not learned the code but the following are some of the "broadcast stations" which I have successfully logged with coils from 19 meters to 50 meters. KKQ, Bollnas, California: VE9CL, Winnipeg, Can.: VE9GW, Bowmanville, Can.: CGA, Drummondville, Can.: W2XU, W1XAZ, W2XAF, W8XK, WND, WOO, W8BN, G1SQ, GFVY, GBS, GBU, VPD, XFD, W8XAU, W3XAL, W8XAL, W9XF and G5SW, Chelmsford, England. This station is a good stand-by and comes over with good loudspeaker volume! I have held them for nearly two hours, i.e., 5 to 7 E.S.T.

Recently I received a letter from England verifying my reception of G5SW and quote from their letter for your information. Their letter is written from the office of WORLD RADIO, Savoy Hill, London, WC2.

"Owing to the large number of requests for the confirmation of reported reception of our Experimental Short Wave Station, 5SW, it has been decided to include such questions among those which this journal answers in the course of its service known as "Which Station Was That?" The conditions under which these questions are answered will be found in the accompanying leaflet, to which special attention is directed."

"For experimental purposes 5SW radiates the London programme at the following times:—Greenwich Time. 12:30 P.M. to 1:30 P.M. and 7 P.M. to Midnight. Except on Saturdays and Sundays."

Recently IIRB, Honduras, has been coming in quite strong, and W8XAL, Crosley Radio Corp., with station at Mason, Ohio, has been coming in with an "awful wallop". Experimental Station VE9GW at Bowmanville, Ontario, Canada, announces that QSL cards will be forwarded to all who report reception.

(Continued on page 366)

Short-Wave Stations of the World

All Schedules Eastern Standard Time: Add 5 Hours for Greenwich Mean Time.

Meters	Kilo-cycles	
4.97-5.35	60,000-36,000	-Amateur Telephony and Television.
5.83	51,400	-W2XBC, New Brunswick, N. J.
6.89	43,500	-W9XD, Milwaukee, Wis. Television. Milwaukee Journal. -W3XAD, Camden, N. J. Television. (Other experimental television permits: 18,500 to 50,300 k.c.; 43,000 to 16,000 k.c.)
7.05	42,530	-Berlin, Germany. Tu. and Thu. 11:30-1:30 p.m. Teletunkent Co.
8.67	31,600	-W2XBC, New Brunswick, N. J.
9.68	31,000	-W8X1, Pittsburgh, Pa.
10.79	27,800	-W6XD, Palo Alto, Calif. M. R. T. Co.
11.55	25,950	-GSSW, Chelmsford, England Experimental.
11.67	25,700	-W2XBC, New Brunswick, N. J.
12.48	24,000	-W6AQ, San Mateo, Calif. (Several experimental stations are authorized to operate on non-exclusive waves of a series, both above this and down to 4 meters.) -Vienna, Austria. Mo., Wed., Sat.
13.92	21,540	-W8XK, Pittsburgh, Pa.
14.00	21,120	-W2XDJ, Deal, N. J.
14.01	21,400	-WJ, Lawrence, N. J., transatlantic phone.
14.13	21,130	-LSM, Monte Grande, Argentina.
14.27	21,020	-LSN (Hurlingham), Buenos Aires, Argentina.
14.28	21,000	-DK1, Poděbrady, Czechoslovakia.
14.47	20,710	-LSY, Monte Grande, Argentina. Telephony.
14.50	20,680	-LSN, Monte Grande, Argentina, after 10:30 p. m. Telephony with Europe. -F8R, Paris-Saigon phone.
14.54	20,520	-PMB, Bandung, Java. After 4 a. m.
14.62	20,500	-W9XF, Chicago, Ill. (WENR).
14.89	20,110	-DWG, Nauen, Germany. Tests 10 a. m.-3 p. m.
15.03	19,950	-LSG, Monte Grande, Argentina. From 7 a. m. to 1 p. m. Telephony to Paris and Nauen (Berlin). -D1W, Nauen, Germany. Press (code) 6:15 a. m. English; 8:30 a. m. and 11 a. m. French, daily. 8:30 a. m. Sundays, French.
15.07	19,900	-LSG, Monte Grande, Argentina. 8-10 a. m.
15.10	19,850	-WMI, Deal, N. J.
15.12	19,830	-FTD, St. Assise, France.
15.20	19,720	-EAG, Madrid, Spain.
15.45	19,100	-FRO, FRE, St. Assise, France.
15.50	19,350	-W2XAC, France. 4 to 5 p. m.
15.51	19,310	-W2XAC. And higher waves. Press wireless.
15.55	19,300	-FTM, St. Assise, France. 10 a. m. to noon.
15.58	19,240	-DFA, Nauen, Germany.
15.60	19,220	-WNC, Deal, N. J.
15.94	18,820	-PLE, Bandung, Java. 5:10-8:10 a. m. and from 2:10 a. m. Tues. and Fri. 7:40-10:40 a. m. Tues. Also telephony.
16.10	18,620	-GBI, Ibadin, England. Telephony with Montreal.
16.11	18,620	-GBU, Rugby, England.
16.33	18,370	-PMC, Bandung, Java.
16.35	18,350	-WND, Deal Beach, N. J. Transatlantic telephony.
16.38	18,310	-GBS, Rugby, England. Telephony with New York. General Postoffice, London. -Z8S, Saigon, Indo-China, 1 to 3 p. m. Sundays.
16.44	18,240	-FRO, FRE, St. Assise, France.
16.50	18,170	-CGA, Drummondville, Quebec, Canada. Telephony to England.
16.57	18,100	-GBK, Ibadin, England. -W9XAA, Chicago, Ill. Testing, mornings.
16.61	18,050	-KQJ, Hollnas, Calif.
16.80	17,850	-PLF, Bandung, Java ("Radio Malabar"). -W2XAD, New Brunswick, N. J.
16.82	17,830	-PCV, Kootwijk, Holland. 9:10 a. m. Sat.
16.87	17,780	-W8XK, Pittsburgh, Pa.
16.90	17,750	-HS1P, Bangkok, Siam. 7-9:30 a. m. 1-3 p. m. Sundays.
17.00	17,610	-Ship Phones to Shore: W8BN, "Leviathan"; GFVV, "Majestic"; GLSQ, "Olympic"; GDLI, "Homerick"; GMIQ, "Belgenland"; work on this and higher channels.
17.25	17,380	-JIAA, Tokio, Japan.
17.34	17,300	-W2XK, Schenectady, N. Y. Tues., Thurs., Sat. 12 to 5 p. m. General Electric Co. -W8X1, Dayton, Ohio -W8XJ, Oakland, Calif. -W7XA, Portland, Ore. -W7XC, Seattle, Wash. -W2XCU, Ampere, N. J. -W9XL, Anoka, Minn., and other experimental stations.
17.52	17,110	-WOO, Deal, N. J. Transatlantic phone. -W2XDO, Ocean Gate, N. J. A. T. & T. Co.
17.55	17,080	-GBC, Rugby, England.
18.10	16,300	-PCL, Kootwijk, Holland. Works with Bandung from 7 a. m. -WLO, Lawrence, N. J.
18.50	16,200	-FZR, Salkon, Indo-China.
18.56	16,150	-GBX, Rugby, England.
18.68	16,060	-NAA, Arlington, Va. Time signals, 11:57 to noon.
18.80	15,950	-PLG, Bandung, Java. Afternoons.
18.90	15,860	-FTK, St. Assise, France. Telephony.
18.93	15,760	-JIAA, Tokio, Japan. 1 p. to 10 a. m. Beam transmitter.
19.01	15,750	-Chi-Hoa, Saigon, Indo-China. Telephony.
19.56	15,340	-W2XAD, Schenectady, N. Y. Broadcasts 3-6 p. m.; Sun., 1-3 p. m.; relaying WGY.
19.60	15,300	-DKY, Lyngby, Denmark. Experimental. -Kunigswinterhausen, Germany. After 7 a. m.
19.66	15,250	-W2XAL, New York, N. Y. -W6XAL, Westminster, Calif.
19.68	15,210	-FYA, Pontoise, France. 9:30-11:30 a. m. Service de la Radiodiffusion, 103 Rue de Grenelle, Paris.
19.72	15,190	-W8XK (KDKA), Pittsburgh, Pa. Tues., Thurs., Sat., Sun., 8 a. m. to noon.
19.83	15,120	-HVJ, Vatican City (Rome, Italy). 5-6 a. m. -JIAA, Tokio, Japan.
19.99	15,000	-CM6XJ, Central Timucuc, Cuba. -LSJ, Monte Grande, Argentina. -VK6AG, Perth, West Australia.

Meters	Kilo-cycles	
20.20	14,850	-HVJ, Vatican City, Sunday, 5 a. m.; Tues. in English.
20.50	14,620	-WMI, Deal, N. J.
20.65	14,530	-KDA, Mexico City, 2:30-3 p. m.
20.70	14,180	-W8XK, East Pittsburgh, Pa. -GBW, Rugby, England. -WNC, Deal, N. J.
20.80	14,120	-VPD, Suva, Fiji Islands.
20.95	14,010	-G2NM, Sunning-on-Thames, England. Saturdays, 3 a. m.; Sundays, 3 p. m.
20.97-21.26	14,000-11,100	-Amateur Telephony.
21.47	14,150	-KZZ, Hollnas, Calif.
21.50	14,010	-Bucharest, Roumania, 2-5 p. m., Wed., Sat.
22.38	13,100	-WND, Deal Beach, N. J. Transatlantic telephony.
22.68	13,220	-Ship Phones.
23.00	13,013	-TGCA, Guatemala City, Rep. Guatemala. 10 p. m. midnight.
23.35	12,850	-W2XD, Schenectady, N. Y. Antipodal program 9 h. Mon. to 3 a. m. Tues. Noon to 5 p. m. on Tues., Thurs. and Sat. General Electric Co. -W2XCU, Ampere, N. J. -WOO, Ocean Gate, N. J. -W9XL, Anoka, Minn., and other experimental relay broadcasters.
23.38	12,820	-Rabat, Morocco, Sun., 7:30-9 a. m. Daily 5-7 a. m. Telephony.
23.46	12,780	-GBC, Rugby, England.
24.11	12,290	-GBU, Rugby, England.
24.46	12,250	-FTN, Ste. Assise (Paris), France. Works Buenos Aires, Indo-China and Java. On 9 a. m. to 1 p. m. and other hours. -GBS, Rugby, England -PLM, Bandung, Java. 7:45 a. m.
24.63	12,280	-Airplane.
24.68	12,150	-GBS, Rugby, England. Transatlantic phone to Deal, N. J. (New York). -FQD, FQE, Ste. Assise, France.
24.80	12,090	-Tokyo, Japan. 5-8 a. m.
24.89	12,045	-NAA, Arlington, Va. Time signals, 11:57 to noon. -NSS, Annapolis, Md. Time signals, 9:57-10 p. m.

(NOTE: This list is compiled from many sources, all of which are not in agreement, and which show greater or less discrepancies; in view of the fact that most schedules and many wavelengths are still in an experimental stage; and that wavelengths are calculated differently in many schedules. In addition to this, one experimental station may operate on a group of several wavelengths which are assigned to a group of stations in common. We shall be glad to receive later and more accurate information from broadcasters and other transmitting organizations, and from listeners who have authentic information as to calls, exact wavelengths and schedules. We cannot undertake to answer readers who inquire as to the identity of unknown stations heard, as that is a matter of guesswork; in addition to this, the harmonics of many local long-wave stations can be heard in a short-wave receiver.—EDITOR.)

24.98	12,000	-FZG, Saigon, Indo-China. Time signals, 2-2:05 p. m.
25.10	11,915	-KQJ, Hollnas, Calif.
25.16	11,920	-FYA, Pontoise, France. Variable beams to French Colonies, 12:30-2 p. m.
25.21	11,880	-W8XK (KDKA), Pittsburgh, Pa. Tues., Thurs., Sat., Sun., 11 a. m.-1 p. m. and Sat. night Arctic programs. Television, Mon. and Fri., 2:30 p. m., 60 lines, 1200 r.p.m. -W9XF, Chicago (WENR). -W2XAL, New York (WBTV). -WUC, Calcutta, India. 9:15-10:15 p. m.; 8-9 p. m.
25.26	11,870	-W2XE, Jamaica, New York (WABD), 7:30 a. m. through to 2 a. m. Sundays-8 a. m. to midnight.
25.31	11,810	-W9XAA, Chicago, Ill. 7-8 a. m., 1-2-4-5:30, 6-7:30 p. m.
25.32	11,800	-W2XAL, New York. -W9XF, Chicago. -VE9GW, Bowmanville, Canada. -I2RO, Rome, Italy. Also relays Naples, 1:30-5:30 p. m.
25.47	11,780	-VE9DR, Drummondville, Quebec, Canada. Chi-Hoa, Saigon, Telephony.
25.50	11,700	-KDA, Mexico City, 3-1 p. m.
25.53	11,750	-GSSW, Chelmsford, England. 7:30-8:30 a. m. 2-2 p. m. to 7 p. m.
25.58	11,720	-CJRX, Middleburgh, Man., Canada.
25.63	11,690	-FYA, Pontoise, France. Intercultural broadcasting, 1-6 h. m.
25.65	11,680	-YVO, Marazay, Venezuela.
25.68	11,670	-K10, Kalulu, Hawaii.
26.00	11,530	-CGA, Drummondville, Canada.
26.10	11,490	-GBK, Ibadin, England.
26.15	11,470	-BOK, S.S. "Elettra," Marconi's yacht.
26.22	11,435	-DHC, Nauen, Germany.
26.44	11,310	-DAN, Norddeich, Germany. Time Signals, 7 a. m., 7 h. m. Deutsche Seewarte, Hamburg.
27.30	10,980	-ZLW, Wellington, N. Z. Tests 3-8 a. m.
27.75	10,800	-GBX, Rugby, England. -TGV, Guatemala City, Guatemala.

Meters	Kilo-cycles	
28.20	10,630	-PLR, Bandung, Java. Works with Holland and France weekdays from 7 a. m.; sometimes after 9:30.
28.11	10,710	-WLO, Lawrence, N. J. -VLK, Sydney, Australia, 1-7 a. m. -PDK, Kootwijk, Holland. -KEZ, Hollnas, Calif. -LSY, Buenos Aires, Argentina.
28.80	10,110	-PDK, Kootwijk, Holland.
28.86	10,390	-GBX, Rugby, England.
29.00	10,250	-T14, Heredia, Costa Rica. Mo., Wed. 7:30-8:30 p. m.; Thu., Sat., 9-10 h. m.
29.51	10,150	-DIS, Nauen, Germany. Press (code) daily: 6 p. m. Spanish; 7 p. m. English; 7:59 p. m. German; 2:30 p. m. English; 5 p. m. German. Sundays: 6 p. m. Spanish; 7:59 p. m. German; 9:30 p. m. Spanish.
30.15	9,950	-GBU, Rugby, England.
30.30	9,890	-LSN, Buenos Aires, phone to Europe. -LSA, Buenos Aires.
30.61	9,790	-EAO, Madrid, Spain.
30.75	9,750	-GBW, Rugby, England. -A2N, Agen, France. Tues and Fri. 3 to 1:15 p. m. -WNC, Deal, N. J.
30.99	9,700	-WMI, Deal, N. J.
30.93	9,690	-LQA, Buenos Aires.
31.10	9,610	-Monte Grande, Argentina, works Nauen irregularly after 10:30 p. m. -RVRI, Leningrad, U.S.S.R. (Glasgow), 2-3 h. m.
31.23	9,600	-LGN, Bergen, Norway.
31.26	9,590	-PCJ, Hiversum (Eindhoven), Holland. Wed. 11 a. m., 3 h. m., Thurs. 9 a. m., 1 p. m., 5-9 p. m., Fri. 1-3, 8 p. m., Sat. 2 a. m. Philips Radio. -VK2ME, Sydney, Australia. -W3XAU, Hylberry, Pa., relays WCAU daily. -VPD, Suva, Fiji Islands.
31.33	9,570	-WIXAZ, Springfield, Mass. (WBZ), 6 a. m. to 10 p. m. daily. Westinghouse Elec. & Mfg. Co. -SRI, Poznan, Poland. Tues. 1:15-1:45 p. m., Thurs. 1:30-8 p. m.
31.36	9,560	-Kunigswinterhausen, Germany, 10 to 11 a. m., 11:30 a. m. to 2:30 h. m. and 3 to 7:30 or 8:30 p. m. Relays Berlin. -NAA, Arlington, Va. -ZL2XX, Wellington, New Zealand.
31.18	9,530	-W2XAF, Schenectady, New York, 5-11 p. m. -W9XA, Denver, Colorado. Relay, KQA.
31.19	9,520	-Relsja, Copenhagen, Denmark. 1 p. m. daily. (Medical ship telephone service, also from Thorburn, Faroe Islands, and Julianehaab, Greenland.)
31.56	9,500	-VK3ME, Melbourne, Australia. Wed. and Sat. 5:7:30 a. m. Amalgamated Wireless, 47 York St., Sydney, Australia.
31.70	9,460	-Radio Club of Buenos Aires, Argentina.
32.00	9,375	-EH9OC, Berne, Switzerland. 3-5:30 p. m.
32.13	9,380	-CGA, Drummondville, Canada.
32.21	9,310	-GBC, Rugby, England. Sundays, 2:30-5 p. m.
32.26	9,290	-Rabat, Morocco, 3-5 p. m. Sunday, and irregularly weekdays.
32.10	9,250	-GBK, Ibadin, England.
32.50	9,230	-FL, Paris, France (Eiffel Tower). Time signals 1:56 a. m. and 1:56 p. m.
32.59	9,200	-GBS, Rugby, England. Transatlantic phone.
32.26	9,010	-GBS, Rugby, England.
32.81	8,872	-NPD, Cavite (Manila), Philippine Islands. Time signals 9:57-10 p. m. 2:57-3 p. m.
32.95	8,830	-Ship Phones.
32.98	8,810	-WSBN, S.S. "Leviathan."
31.00	8,820	-VK3UZ, Melbourne, Australia. Mon., Thu., 8:00-8:30 a. m.; Mon., 11-11:30 p. m.
31.50	8,690	-W2XAC, Schenectady, New York.
31.68	8,650	-W2XCU, Ampere, N. J. -W9XL, Chicago
31.68	8,650	-W3XE, Baltimore, Md. 12:15-1:15 p. m. 11:15-12:15 p. m. -W2XV, Long Island City, N. Y. -W8XAG, Dayton, Ohio. -W4XG, Miami, Fla. -W3XX, Washington, D. C. And other experimental stations.
31.71	8,630	-WOO, Deal, N. J.
32.00	8,570	-W2XDO, Ocean Gate, N. J. -RV15, Kiblaarsok, Siberia, 5-7:30 a. m. KC21M, Guayaquil, Ecuador.
32.02	8,550	-WOO, Ocean Gate, N. J.
32.50	8,450	-PRAG, Porto Alegre, Brazil. 8:30-9:00 a. m.
32.52	8,420	-PLW, Bandung, Java.
32.02	8,100	-EATH, Vienna, Austria. Mon. and Thurs. 5:30 to 7 p. m. -JIAA, Tokyo, Japan. Tests 5-8 a. m.
32.13	8,015	-Airplane.
32.65	7,980	-VK2ME, Sydney, Australia.
32.80	7,930	-Eocheritz, Germany. 1 to 3 p. m. Reichspostzentramt, Berlin.
32.00	7,890	-VPD, Suva, Fiji Islands. -JIAA, Tokio, Japan (Testing).
32.30	7,830	-PDV, Kootwijk, Holland, after 9 a. m.
32.60	7,770	-FTF, Ste. Assise, France. -PCK, Kootwijk, Holland. 9 a. m. to 7 p. m.
32.15	7,660	-FTL, Ste. Assise.
32.10	7,610	-HKF, Bogota, Colombia. 6-10 a. m.
32.74	7,520	-CGE, Calgary, Canada. Testing, Tues., Thu. 11 a. m.-noon; 1-2, 4-5, 7-8 h. m. Test after midnight. I.S.W.C. program 11 p. m. Wed. A. P. 31.
32.80	7,500	-"El Prado," Niobamba, Ecuador. Thurs., 9-11 p. m.
40.00	7,500	-Radio-Touraine," France.
40.20	7,460	-YR, Lyons, France. Daily except Sun. 10:30 to 1:30 a. m.
40.50	7,410	-Eberswalde, Germany. Mon., Thurs., 1-2 p. m.
40.70	7,370	-X26A, Nuevo Laredo, Mexico. 9-10 a. m., 11 a. m.-noon; 1-2, 4-5, 7-8 h. m. Test after midnight. I.S.W.C. program 11 p. m. Wed. A. P. 31.
40.90	7,320	-ZTJ, Johannesburg, So. Africa 9:30 a. m.-2:30 p. m.

(Continued on opposite page)

Short-Wave Stations — When to Listen

(Continued from opposite page)

Meters	Kilo-cycles	Station	Meters	Kilo-cycles	Station	Meters	Kilo-cycles	Station		
11.16	7,230	DOA, Doberitz, Germany.	19.50	6,060	ZLO, Nairobi, Kenya, Africa. Mon., Wed., Fri., 10 a.m. to 1:30 p.m. From 10:30 Tuesday, Thursday, Sunday.	92.50	3,256	W9XL, Chicago, Ill.		
41.79	7,220	HB9D, Zurich, Switzerland. 1st and 3rd Sundays at 7 a.m., 2 p.m.	19.50	6,050	W3XAU, Byberry, Pa. Relays WCAE.	92.5-91.9	3,241-3,160	KFR, WJE, City of Seattle. Wash., Light Dept.		
		... Budapest, Hungary. 2:30-3:10 a.m., Tu., Thurs., Sat. Budapest Technical School, M.R.C., Budapest, Műegyetem.	49.50	6,040	VE9CF, Halifax, N. S., Canada. 11 a.m. to noon, 5-6 p.m. On Wed., 8-9; Sun., 6:30-8:15 p.m.	94.20	3,181	KQS, KQT, City of Los Angeles, Calif. Water Dept.		
11.67	7,195	VS1AB, Singapore, S. S. Mo., Wed. and Fri., 9:30-11 a.m.	49.75	6,030	HKD, Barranquilla, Colombia.	95.00	3,156	PK2AG, Samarang, Java.		
12.00	7,110	HKX, Bogota, Colombia.	49.80	6,020	W9XAQ, Chicago, Ill. (WMAQ).	95.48-97.71	3,112-3,070	Aircraft.		
12.70	7,020	EAR125, Madrid, Spain. 6-7 p.m. Wed., Sat.	49.97	6,000	W2XAL, New York.	96.03	3,121	WOO, Deal, N. J.		
12.90	6,990	CT1AA, Lubon, Portugal. Fridays, 5-7 p.m.			PK3AN, Sourabaya, Java. 6-9 a.m.	97.53	3,076	W9XL, Chicago, Ill.		
13.00	6,980	EAR110, Madrid, Spain. Tues. and Sat., 5:30 to 7 p.m.; Fri., 7 to 8 p.m.			VE9CA, Calgary, Alta., Canada.	98.95	3,030	Motala, Sweden. 11:30 a.m.-noon, 4-10 p.m.		
13.60	6,875	FBMC, Casablanca, Morocco. Sun., Tues., Wed., Sat.			W9XF, Chicago, Ill.			VE9AR, Saskatoon, Sask., Canada.		
13.70	6,860	KEL, Bolinas, Calif.			W2XBR, New York, N. Y. (WBNY).	101.7	to 105.3	meters—2,850 to 2,950 kc. Television.		
13.80	6,810	CFA, Drummondville, Canada.			ZL3ZC, Christchurch, New Zealand. 10 p.m. to midnight, Tuesdays, Thursdays and Fridays.			W1XAV, Boston, Mass. 1-2, 7:30 to 10:30 p.m. daily ex. Sun. Works with W1XAV 10-11 p.m. Shortwave & Television Corp.		
41.10	6,775	WND, Deal, N. J.			HRB, Tegucigalpa, Honduras. 9:15 p.m. to midnight, Mon., Wed., Fri. From 11 p.m. to midnight, Sat. Int. S. W. Club program.			W2XR, Long Island City, N. Y., 4 to 10 p.m. ex. Sundays. Silent 7-7:30 Sat. Radio Pictures, Inc.		
11.90	6,675	TGW, Guatemala City, Guatemala. 9-11:30 p.m.			REN, Moscow, Russia. 10 a.m. 5 p.m. English on Sun. Mo., Thur.	105.9	2,833	W6XAN, Los Angeles, Calif.		
41.59	6,660	FBKR, Constantine, Algeria. Mo., Fri., 5 p.m.			YV2BC, Caracas, Venezuela. 7:15-11 p.m. daily ex. Monday.	105.3	to 109.1	meters—2,750 to 2,850 kc. Television.		
		HKM, Bogota, Colombia. 9-11 p.m.	50.23	5,970	HVJ, Vatican City (Rome). 1-1:30 p.m. Sundays and holidays, 4-5 a.m.			W2XAB, New York City. Columbia Broadcasting System. 2-6, 8-11 p.m. On Sat., 7-10 p.m. to 10 p.m. Works with W2XAB on 18.99 meters.		
43.50	6,760	RFN, Moscow, U.S.S.R. (Russia). 9 a.m.-4 p.m.	50.80	5,900	HKE, Medellin, Colombia. 8-11 p.m.			W2XBO, Long Island City, N. Y.		
46.05	6,515	WOO, Deal, N. J.	51.22	5,800	XDA, Mexico City. 10-11 p.m.			W9XAA, Chicago, Ill.		
16.10	6,180	TGW, Guatemala City, Guat. 9-11 p.m.	51.10	5,835	HKD, Barranquilla, Colombia. 7:45-10:30 p.m. Mo., Wed., Sat., 2-4, 7:45-8:30 p.m. Sunday. Elias J. Pellet.			W9XK, West Lafayette, Ind.		
46.60	6,130	REN, Moscow, U.S.S.R. Tues., Thurs. and Sat., 6-7 a.m.	52.50	5,710	VE9CL, Winnipeg, Canada.	108.8	2,758	VE9CI, London, Ont., Canada.		
46.70	6,125	W2XCU, Ampere, N. J.	52.72	5,600	5,510—Aircraft.	110.2	2,722	Aircraft.		
		W9XL, Anoka, Minn.	51.02	5,550	W8XJ, Columbus, Ohio.	112.1	2,938	W6XAF, Sacramento, Calif. State Dept. of Agriculture.		
16.70	6,125	W3XL, Bound Brook, N. J. Relays WJZ. Fri., 5-6:15 p.m.; 11 p.m.—1 a.m.; Sat., 1:30-6:15 p.m.; 11 p.m.—1 a.m.	51.51	5,500	W2XBH, Brooklyn, New York City (WBBC, W4G1).	121.5	2,470	Police and Fire Departments.		
17.00	6,380	HCIDR, Othello, Ecuador. 8-11 p.m.	58.00	5,170	OKIMPT, Prague, Czechoslovakia. 1-3:30 p.m. Tu. and Fri.			KGOZ, Cedar Rapids, Ia.—WRDQ, Toledo, Ohio.		
		XIF, Mexico City, Mex. 7-9 p.m.; 11 p.m. 1 a.m.	60.26	4,975	GBC, Rugby, England.	122.0	2,458	WPDG, Youngstown, Ohio.		
17.35	6,335	W10XZ, Airplane Television.	60.30	4,975	W2XAV, Long Island City, N. Y.	122.3	2,452	WRBH, Cleveland, O.—KGPP, Portland, Ore.		
		VE9AP, Drummondville, Canada.	61.22-62.50	4,800	1,900—Television.			WPKD, Milwaukee, Wis.—KGPH, Oklahoma City, Okla.		
		CN8MC, Casablanca, Morocco. Mon., 3-4 p.m.; Tues. 7-8 a.m.; 3-4 p.m. Relays Rahat.	62.50	4,800	W2XV, Long Island City, N. Y.	123.0	2,440	WPDF, Flint, Mich.—WNDA, Miami, Fla.—WPPD, Philadelphia, Pa.		
47.77	6,280	... Strasbourg, France (3).	62.56	4,795	W9XAM, Elgin, Ill. (Time signals.)			W3XB, Portable.		
		WWV, Bureau of Standards, Washington, D. C. Tuesdays, 2-4, 10-12 p.m. Standard Frequency Code.	63.13	4,750	W00, Ocean Gate, N. J.	123.9	2,422	WJL, Buffalo, N. Y.—KGPE, Kansas City, Mo. (8.99 State).		
17.81	6,270	HKC, Bogota, Colombia. 8:30-11:30 p.m.	63.79	4,700	W1XAB, Portland, Me.	124.2	2,416	WPDJ, Columbus, O.—WPDE, Louisville, Kentucky.		
18.00	6,250	HKA, Barranquilla, Colombia. 8-10 p.m. ex. Mo., Wed., Fri.	65.22-66.67	4,500	1,600—Television.			KGFB, Minneapolis, Minn.—WPDJ, Pasaic, N. J.		
18.62	6,170	HRB, Tegucigalpa, Honduras. 5-6, 9-12 p.m., Mon., Wed., Fri., Sat. Int. S. W. Club program. Sat., 11:30-12 p.m.	67.65	4,430	DOA, Doberitz, Germany. 6-7 p.m., 2-3 p.m., Mon., Wed., Fri.			WPD5, St. Paul, Minn.—WPDA, Tulare, Calif.		
18.74	6,155	W9XAL, Chicago, Ill. (WMAQ), and Airplanes.	70.00	4,280	OHK2, Vienna, Austria. Sundays, first 15 minutes of hour from 1 to 7 p.m.	124.5	2,410	WCKC, WRDR, WMO, Detroit (Helle Isle, Grasse Pointe, Highland Park, Mich.—WPDW, Washington, D. C.		
18.83	6,140	W8XK, East Pittsburgh, Pa. Tues., Thurs., Sat., Sun., 5 p.m. to midnight.	70.20	4,273	RV15—Khabarovsk, Siberia. 1-7 a.m. GDLJ, S.S. "Imerie".			KGPD, San Francisco, Calif.		
48.99	6,120	... Motla, Sweden. "Rimradio," 6:30-7 a.m., 11-4:30 p.m. Holidays, 5 a.m. to 5 p.m.	71.77-72.08	4,190	1,100—Aircraft.			KGPF, Vallejo, Calif. Police Dept.		
		F3ICD, Chi-Hoa (Saigon), Indo-China. 6:30-10 a.m.	71.82	4,175	Ship Phones.	125.1	2,398	W9KL, Chicago, Ill.—W2XCU, Ampere, N. J.		
		W2XE, New York City. Relays WAB.	72.87	4,116	W00, Deal, N. J.			WPD7, Kokomo, Ind. Police Dept.		
		FL, Eiffel Tower, Paris. 5:30-5:45 a.m., 5:15-12:30, 4:15-4:45 p.m.	74.72	4,105	NAA, Arlington, Va. Time signals. 9:57-10 p.m., 11:57 a.m. to noon.	129.0-129.0	—Aircraft.	136.0	2,306	DDDX, S.S. "Bremen" and "Europa" sailing.
		... Toulouse, France. Sunday 2:30-4 p.m.	80.00	3,750	FBKR, Constantine, Tunis. Africa. Mon. and Fri.	136.4	to 142.9	meters—2,100 to 2,200 kc. Television.		
49.10	6,110	VE9CG, Calgary, Alta., Canada.			IZRO (Prato Smeraldo), Rome, Italy.			W2XBS, New York, N. Y., 1,200 ft.P.M., 60 lines deep, 72 wide. 2-5 p.m., 7-10 p.m. ex. Sundays, National Broadcasting Co.		
16.15	6,100	W3XAL, Bound Brook, N. J.			... Torino, Italy.			W2XR, Long Island City, N. Y. 48 and 60 line, 5-7 p.m. Radio Pictures, Inc.		
		VE9CF, Halifax, N. S., Canada. 6-10 p.m., Tu., Thu., Fri.			DOA, Doberitz, Germany. (Television).			W3XAD, Camden, N. J.		
19.17	6,095	VE9GW, Bowmanville, Ontario, Canada.			G2M, Sounding-on-Thames, England. 5 a.m. Sunday.			W2XCW, Schenectady, N. Y.		
19.31	6,090	W9XAA, Chicago, Ill. (WCFB). 6-7 a.m., 7-8 p.m., 9:30-10:15, 11-12 p.m. Int. S. W. Club programs. From 10 p.m. Saturday to 6 a.m. Sunday.	81.24	3,560	OZ7RL, Copenhagen, Denmark. Tues. and Fri. after 6 p.m.			W8XAV, Pittsburgh, Pa. 1,200 ft.P.M., 60 lines, 1:30-2:30 p.m., Mon., Wed., Fri.		
19.40	6,070	VE9CS, Vancouver, B. C., Canada. Fridays before 1:30 a.m., Sundays, 9 and 10:30 p.m.	81.46-85.66	3,550	3,500—Amateur Telephony.			W9XAP, Chicago, Ill.		
		... Johannesburg, So. Africa. 10:30 a.m.—3:30 p.m.	86.50-86.00	3,190	3,160—Aircraft.			112.9	to 150	meters—2,000 to 2,100 kc. Television.
49.16	6,065	SAJ, Motla, Sweden. 6:30-7 a.m., 11 a.m. to 1:30 p.m.						W2XAP, Jersey City, N. J.		
19.50	6,060	W8XAL, Cincinnati, Ohio. Relays W1AW. 6:30-10 a.m., 1-3 p.m., 6 p.m. to 2 a.m., daily. Sunday after 1 p.m.						W2XCR, Jersey City, N. J. 8-5, 6-9 p.m. ex. Sun.		

(Continued on page 362)

"Star" Short Wave Broadcasting Stations

The following stations are reported regularly by many listeners, and are known to be on the air during the hours stated. You should be able to hear them on your own short-wave receiver. All times E.S.T.

- G5SW, Chelmsford, England. 25.53 meters. Monday to Friday, 1:45 p.m. to 7:00 p.m. Signs off with the midnight chimes of Big Ben, in London.
- HVJ, Vatican City. Daily, 5:00 to 5:15 a.m. on 19.84 meters; 2:00 to 2:15 a.m. on 50.26 meters; Sunday 5:00 to 5:30 a.m. on 50.26 meters.
- 12RO, Rome, Italy. Daily on 25.4 meters from 11:00 a.m. to 12:30 p.m., and 3:00 to 5:30 p.m. Woman announcer.

- VK2ME, Sydney, Australia. 31.28 meters. Sunday morning from 1:00 to 3:00 a.m.; 5:00 to 9:00 a.m.; and 9:30 to 11:30 a.m.
- FYA, Pointoise, France. On 19.68 meters, 9:30 a.m. to 12:30 p.m.; on 25.2 meters, from 1:00 to 3:00 p.m.; and on 25.63 meters from 4:00 to 6:00 p.m.
- Konigs-Wusterhausen, Germany. On 31.38 meters, daily from 8:00 a.m. to 7:30 p.m.
- HKD, Barranquilla, Colombia. On 50 meters, Monday, Wednesday and Friday, 8:00 to 10:30 p.m.; Sunday, 7:45 to 8:30 p.m.
- VE9GW, Bowmanville, Ontario, Canada. 25.4 meters, from 1:00 to 10:00 p.m.

- HRB, Tegucigalpa, Honduras. 48.62 meters. Monday, Wednesday, Friday, and Saturday, 5:00 to 6:00 and 9:00 to 12:00 p.m.
- T14, Heredia, Costa Rica, Central America. 29.3 meters, Monday and Wednesday, 7:30 to 8:30 p.m.; Thursday and Saturday, 9:00 to 10:00 p.m.
- XDA, Mexico City. 25.5 meters. Daily, 3:00 to 4:00 p.m.
- F3ICD, Chi-Hoa, French Indo-China. 49.1 meters. Daily from 6:30 to 10:30 a.m.
- RV15, Khavarovsk, Siberia. 70.1 meters. Daily, from 3:00 to 9:00 a.m.

Short Wave Question Box

Edited by R. William Tanner, W8AD

Capacity Values

S. E. Zimmerman, Turtle Creek, Pa., desires the following information:

(Q.) What are the values of C to C5 and R1 to R3 (in the circuit on Page 227 Dec.-Jan. Issue)?

(A.) You are advised to read the article again, for all constants are given.

(Q.) Approximately how many turns should the coil have, for waves of 75 to 100 meters?

(A.) L1 may have 30 turns, and L2 10 turns; wire gauge No. 30 D. C. C. on a form 1 1/2" in diameter.

Simplest 1-Tube Set

John McMessor, Southington, Conn., desires:

(Q.) A circuit of the simplest one tube battery receiver.

(A.) Such a circuit is given in these columns. C is a midget variable condenser of .000025 mf. capacity, C1 and C3 .00014 mf., C2 is .0001 mf., L and L1 are the plug-in coils and may be any good make. R is a 2 to 5 megohm grid-leak and R1 is a filament ballast resistor for one 201A tube.

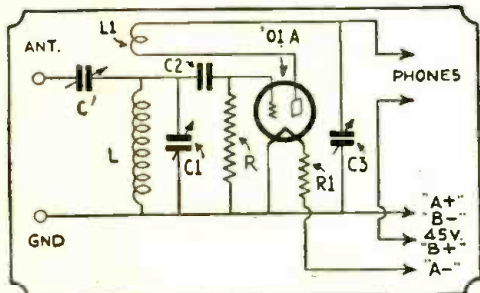

Hook-up for simple "one-tube" S-W receiver; an R.F. choke (85 M.H.) is advisable in series with phones.

Dynatron Oscillator

H. Wm. Covert, Baco, N. Y., writes:

(Q.) Can you publish a circuit for a dynatron oscillator, using a '24 to oscillate effectively at 9 meters?

(A.) A dynatron WILL NOT oscillate on waves below about 60 or 70 meters. At least, in my own experiments, I have never been able to make them work any lower. Even above these waves, it is generally necessary to try a dozen or more tubes to find one that will work satisfactorily.

Hartley Transmitter

T. Jones, Kansas City, Kansas, writes as follows:

(Q.) I would like to have a circuit of a Hartley transmitter using a '45 tube.

(A.) The circuit is given in these columns.

(Q.) What would be the power output of this circuit?

(A.) Probably the same as a normally operated '10, about 5 watts.

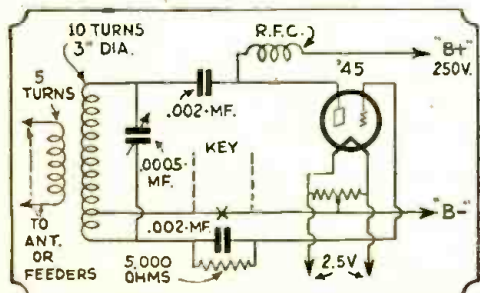

Hartley transmitter circuit, using a '45 tube.

Transmitter Inductances

Louis Miller, Chicago, Ill., writes:

(Q.) Please give number of turns of copper tubing to be used in place of original coils in 85 meter phone transmitter described in the Dec.-Jan. issue.

(A.) Use the same number of turns as specified in article. The capacity of the tuning condensers is sufficient to compensate for the small variation in inductance.

(Q.) Please print circuit for doubling down to 40 meters.

(A.) Frequency doubling in this circuit should not be attempted without adding another stage and this would mean an entirely new design.

(Q.) How may I connect a milliammeter to determine watts input?

(A.) This should be connected in the "B" positive lead to the last or output stage.

Modulator Query

Charles Coverdale, Keansburg, N. J., wants to know:

(Q.) How to connect a modulator to transmitter, and use less plate voltage than the modulated amplifier.

(A.) Such a procedure would result in only a very small percentage of modulation and would be unsatisfactory.

Choke Location

F. E. Litner, Torrington, Conn., asks:

(Q.) In regard to the article by Walter Doerle, Dec.-Jan. Issue, what is the value of the R.F. choke and where is it placed?

(A.) This should have a value of 85 M.H. and would be connected between the A.F. transformer and fielder connection on coil base.

Receiver Queries

Walter Wasama, Detroit, Mich., and Jonas Hamilton, Iowa City, Iowa, both request:

(Q.) The values of condensers and resistors of the "1930 Short Wave Receiver," Page 474 April-May issue; also coils.

(A.) The inductances L2 and L3 are any good make of coils. L1 should be exactly like L2 but a .000025 mf. midget condenser must be connected in series with the antenna. C1 and C2 .00014 mf., C3 .000025 mf., R1 2 megohms, R2 200 ohm potentiometer, R3 10 ohm rheostat, C5 .00035 mf. The R.F. choke should be one designed for short waves. The A.F. transformer may be 3 to 1 ratio. C6 about .002 mf.

Special Tubes

Joseph Wilkins, Cincinnati, Ohio, desires to know:

(Q.) If there are any UV two volt tubes on the market.

(A.) There are none that I know of.

(Q.) Can an RCA catacomb using 199 tubes be adapted to a short wave super?

(A.) These catacombs are peaked around 30 K.C. which makes them unsuitable for short wave supers. Signals can, of course, be brought in, but with many squeals as well as image frequency interference.

Television in Florida

W. D. Randall, Orlando, Fla., wants to know: (Q.) If it is possible to bring in television pictures in Florida?

(A.) It certainly should be possible providing the air is sufficiently clear of your famous static.

(Q.) What circuit is best for foreign reception?

(A.) The superhet cannot be excelled for foreign reception.

(Q.) Where can I get a list of all the broadcast stations in the world?

(A.) The Radio Call Book Co., Chicago, Ill., publishes a book on this.

Crystal Detector for S.W.'s

J. L. Cavanagh, LaGrange, Ill., asks:

(Q.) Can a crystal detector be used in short wave sets?

(A.) Crystal detectors, if of a stable type, can be used very easily. If the builder desires a two tube set, detector and A.F., a crystal can be added to the two tubes in such a manner that the set is far more sensitive. A circuit for this is given in these columns. Only a carborundum crystal has been found stable enough when tuned R.F. is employed. The two sets of coils may be any make desired. Tuning condensers of .00014 mf. are advised. A '35 variable-mu tube is used as an R.F. amplifier and a '27 as a regeneration tube. In such a circuit feedback is practically eliminated; both sensitivity and selectivity are comparatively high.

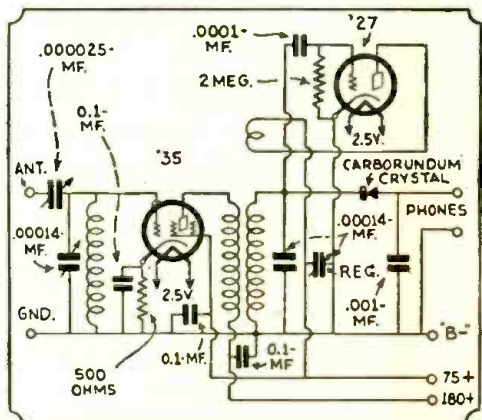

The "crystal detector" is staging a come-back, judging by the interest displayed lately.

Crystal Detector Again!

Adams Brock, Grand Rapids, Mich., wants the following data:

(Q.) Can you publish any data on the use of a crystal detector in a tuned R.F. hookup?

(A.) The crystal again! An article will probably appear on this subject in the near future, as there seems to be considerable interest shown in crystals just now.

(Q.) What type of crystal would be best, from the standpoint of stability?

(A.) The carborundum type is very stable and, when operated with one or more T.R.F. stages, no battery adjustment is needed.

(Q.) Can you give a circuit of a device for measuring the field strength of various antennas used for transmitting? I understand a crystal is used for this.

(A.) The circuit is given in these columns. The coil and variable condenser will be designed for the wave of the transmitter. The coil is coupled to a 2 turn coil shunted from the shielded box and crystal detector. A milliammeter, 0 to 1 M.A., is placed in the output circuit of the crystal rectifier. The radiation qualities of an antenna in different directions may be determined by this efficient little device. (Continued on page 348)

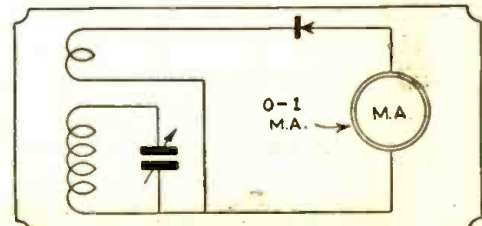

Crystal and milliammeter are used in this circuit to measure field strength.



THE FINEST BROADCAST RECEIVER THAT CAN BE HAD

**In the 716-683
Ten-Tube Broadcast
Two-Unit Super
Pentodes in Push-Pull
Three-Vario-Mu Tubes
Double Tone-Control
Fractional Microvolt
Sensitivity
10 kc. Selectivity
11 1/4" Electro-Dynamic
Speaker**

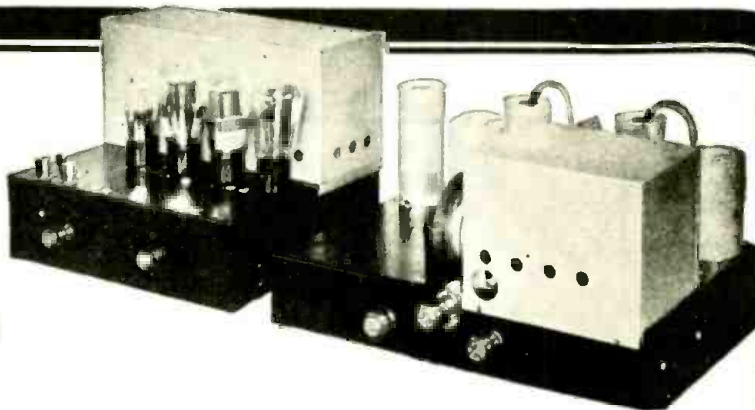

The 716 tuner as described above, completely factory wired, tested and RCA licensed. Size 16 1/2" long, 10 1/4" deep (exclusive of controls) 7 3/4" high. Shipping weight 25 lbs. Price \$69.50 LIST

The 683 amplifier is intended primarily for use with the 716 Tuner. Supplies required B, C, and heater currents. Designed to use with 855B Speaker (800 ohm field). See Page 7 of catalog for complete description. Factory wired and tested, RCA licensed. Price \$69.50 LIST

No All-Wave Receiver Will Beat the 726SW In the 726SW

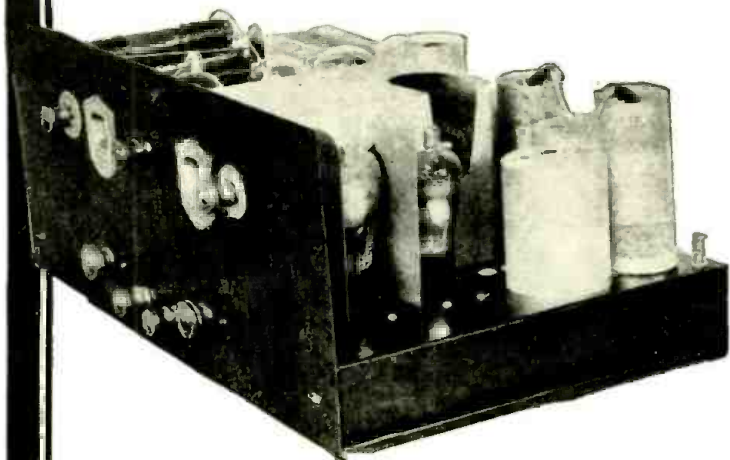

**Nine-Tube Broadcast Super
Eleven-Tube Short-Wave
Super
No Plug-in Coils
Pentodes in Push-Pull
Three Vario-Mu Tubes
Sensitivity Between .45 and .7
Microvolts per Meter
Selectivity Absolute 10 kc.
11 1/4" Electro-Dynamic
Speaker**

Tubes required: 2-'24's, 3-'27's, 3-'51's, 2-'47's, 1-'80.
726SW All-Wave Superheterodyne, complete as described above, wired, tested, licensed, including S-M 855 11 1/4" electro-dynamic speaker unit. Size 20 1/2" long, 12" deep, 8 1/2" high. 110 volt A. C. Price \$139.50 LIST

SILVER-MARSHALL, Inc.
6419 West 65th Street Chicago, U. S. A.
Canadian Division:
SILVER-MARSHALL of CANADA, Ltd.
75 Sherbourne Street, Toronto
Export Office: 41 Water Street, New York City, U. S. A.

SILVER-MARSHALL, Inc.
6419 W. 65th Street, Chicago, U. S. A.

Please send me full technical details on the S-M 716-683 (enclosed you will find 2c).

Please send full technical details on the S-M 726SW (enclosed you will find 2c).

Please send me FREE your November General Parts Catalog.

Name

Address

S-W Audio Amplifier

Roger Hill, Leominster, Mass., requests:

Q. 1. Will you kindly give details of an audio amplifier, with an '01A first and a '71A push-pull power stage?

A. 1. The schematic circuit is shown in a diagram reproduced herewith. The

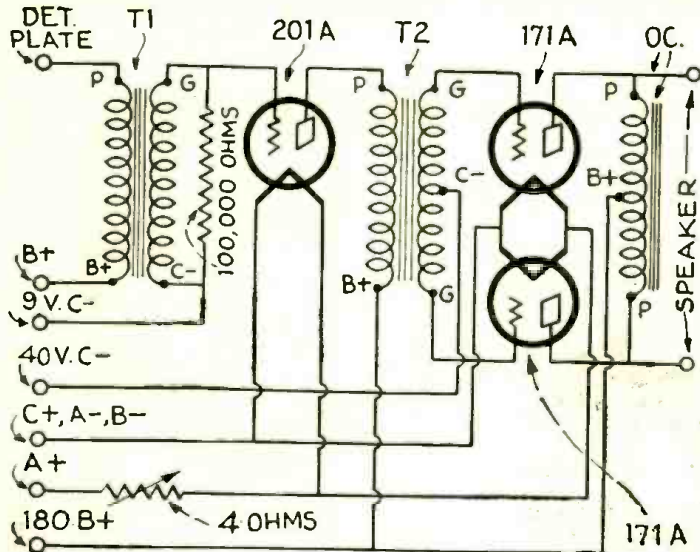

parts may be mounted on a 6x7-inch wooden baseboard. The first transformer T1 is a 2-to-1 ratio type; the second, T2, is a standard push-pull type. Either a three-terminal output choke OC or a regular output transformer may be used to feed into the speaker. The filament rheostat has a value of 4 ohms.

Socket Power Unit

Blair K. Thorn, Margate City, N. J., asks:

Q. 1. For data on the Philco "Type S-604" socket-power unit.

A. 1. The Philadelphia Battery Co., Philadelphia, Pa., will furnish you with a diagram of this unit, which will enable you to make any changes you desire.

Infra-Red Ray Transmitter

R. K. Ruch, Allentown, Penna., wants to know:

Q. 1. Can you supply details on an infra-red ray transmitter and receiver?

A. 1. We have no information at hand on such apparatus.

SHORT WAVE QUESTION BOX

(Continued from page 346)

What Is Zero Beating?

Clarence Peyton, Byesville, Ohio, sends in the following questions:

Q. 1. What is "zero beating"?

A. 1. This means tuning in a station with the detector oscillating. On tuning slowly, the station is first heard as a very high pitched squeal, which diminishes in pitch to zero. As the tuning is continued, the pitch will go from zero to high again. In other words, two squeals will be heard for each station. Between these squeals, the modulations of the station will come through clearly.

Q. 2. When using a good R. F. choke, which is the better connection for the tickler—series or shunt feed?

A. 2. Both should give equal results, from the viewpoint of signal strength or selectivity. However, it is always well, in a short-wave receiver, to keep as much of the R. F. current as possible from the R. F. choke. The series method accomplishes this.

Q. 3. Are better results secured by coupling the antenna to the secondary, through a series condenser, than by using a separate primary?

A. 3. This depends upon the receiver; capacitive coupling gives greater gain

when tuned R. F. is employed ahead of the detector or when the detector is the first detector of a short-wave super-heterodyne. The degree of selectivity depends upon the length of the antenna and value of the coupling condenser. With this method, a short antenna (5 to 10 feet long) will give startling results; in fact, 3 to 5 feet may be used without the coupling condenser.

The capacitive coupling scheme is not advisable for straight regenerative sets; since the capacity must be of a very low value, in order to produce "hole-less" tuning.

Regeneration With Space-Charge Detector

H. Peterson, Detroit, Mich., writes:

Q. 1. I have built a Super Short-Wave Converter, for use with my "S-M 722" broadcast receiver. The "B" voltages are all taken from the power pack in the receiver, and that for the inner grid of the space-charge, short-wave detector V₁ is taken directly from the screen-grid leads of the broadcast tubes; the oscillator plate voltage comes from the same source. Signals are very weak, in fact, nowhere near as loud as those obtained on a plain regenerative set. Can you advise me as to the trouble?

A. 1. Your trouble lies entirely in the voltage applied to the inner grid of the space-charge detector. As this is in the vicinity of 70 volts in the "S-M 722" receiver, it will have to be cut down to the correct value by means of a variable 50,000-ohm resistor R₂, connected as shown in the diagram herewith.

Q. 2. How can the tuning of the first-detector circuit of this converter be made sharper? I do not care to add any more tubes or tuned stages.

A. 2. Regeneration in the space-charge detector could very easily be added by center-tapping the secondary coil (L₂) and connecting as in the second diagram. A special low-inductance R. F. choke will be needed, located close to the detector plate. This must be capable of effectively blocking the high-frequency currents and passing the I. F. currents. A total of 200 turns of No. 36 enamel wire, on a 1/2-inch form, has been found about right for a choke in this position. The regeneration condenser C should be a 25-mmf. midget type.

SPACE CHARGE DETECTOR

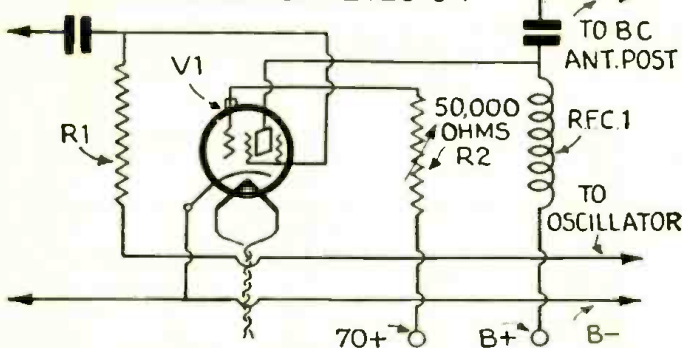

Above—Hook-up for space-charge detector, using variable resistor R₂ to adjust grid voltage. At Right—Obtaining regeneration in space-charge detector circuit by using center-tapped secondary coil L₂.

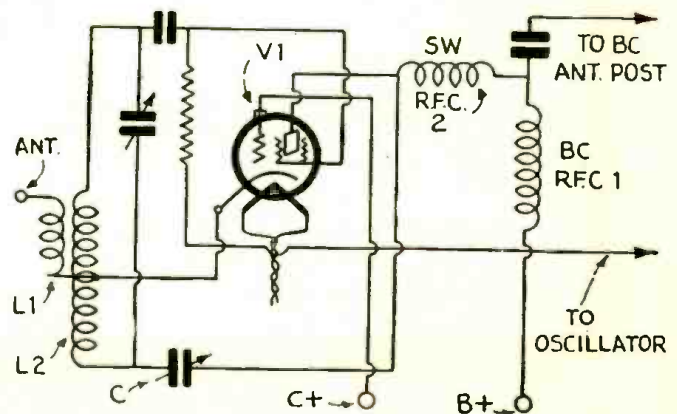

A First Class "Ham" Station

By GORDON I. HENRY, W9DFR

(Continued from page 315)

A split antenna coil must be used to load the tubes evenly. Ten turns of one-eighth inch tubing will be large enough for all bands. The antenna ammeter is in the center at the point of highest impedance and should have a range of zero to one and one-half.

Tuning the Various Stages

Assuming the transmitter to be properly wired, we may now proceed to tune the different stages. The oscillator milliammeter will drop sharply when the tank condenser of that stage is tuned to resonance with the crystal. Care should be taken to see that not more than 250 volts is applied to this stage, or injury may result to the crystal. Voltage regulation is secured by means of R3. A flashlight bulb with one turn of wire held close to the inductance will show whether or not the stage is oscillating. For another indication, watch the milliammeter of the first frequency doubler. It will not read more than five mills until excited by the oscillator.

After the oscillator is operating properly, clip the two excitation leads of the power amplifier on the first frequency doubler; remove the tube from the second doubling stage; and then tune the tank of doubler one until the milliammeter shows a dip. The flashlight bulb should light when held close to L2, if the tank is tuned to a harmonic. With the proper coils in L4 and L5 for the 7,000-kilocycle band, tune C5 with the key open until the flashlight bulb lights when held close to the tank coil, L5. Then to neutralize, the two condensers designated as C7 are rotated together until the light disappears.

The bulb may now be removed and the key closed. C5 should then be readjusted carefully for minimum plate current; if everything is operating properly the plate current will be from forty to eighty milliamperes. The antenna is coupled to the amplifier and brought into resonance by means of C8 and the clips on L6. The same number of turns should be used in each antenna coil; thus providing an ideal coupling system for a zeppelin-type antenna.

After all other adjustments are made, resistance R4 is varied for maximum antenna current. This last adjustment is important and should not be overlooked, especially when using the last stage as a straight oscillator; since the antenna current is increased by as much as a quarter-ampere.

Circuit Constants

A word is added here about the circuit constants. While some of the values may be changed without serious loss, the builder will do well to use those values designated.

In the case of L4, if any changes are made in the number of turns or diameter or size of wire, the coil must be brought into resonance in the following manner: Open S1 and reverse S2 so that the last stage is operating as an oscillator. Turn C5 until the milliammeter shows the lowest reading and, if this happens with the condenser at maximum, remove a turn or two from L4 and try again. If the dip



RELIABLE Short Wave RECEPTION

To Use with your present Set, attached in 10 minutes—NATIONAL NC-5—most powerful converter made.



NATIONAL NC-5 Short-Wave Converter for use with any radio set

No trouble to connect this powerful NC-5 to any radio set. Simply move the antenna wire from the set to the proper binding post on the converter—connect the converter wire to antenna post on the set and plug the electrical connection into baseboard alongside the one that goes to your set. No need to disconnect when receiving ordinary broadcasts.

WORKS WITH ANY SET

Owing to the super-power of the NATIONAL NC-5 Converter (there are two extra stages of amplification), it will bring in broadcasts and code on short-waves from all over the world on any radio set.

SINGLE CONTROL TUNING

Specially designed to make circuits "track" each other accurately. No interlocking or "dead spots." Operation is stable over the range.

NO PLUG-IN COILS

The NC-5 Converter has a new coil-switching system with practically perfect results for converter use, but without the inconvenience of plug-in coils. The new design helps, but R-39, the remarkable low-loss dielectric, really makes it possible. No ordinary insulating material works as well. There is no intercoupling between coils.

A Change in Color of Dial Light Indicates Which Coils Are in Circuit

ATTRACTIVE — COMPACT

Size, 8" x 17 1/2" x 12". Standard Model. In beautifully finished metal cabinet.

DE LUXE MODEL

In hand-rubbed solid mahogany case with genuine inlay in front panel. Harmonizes with the most beautiful radio sets.

For Serious Short-Wave work, this outstanding instrument, the NATIONAL SW-5 THRILL-BOX

For those who wish to go into serious short wave reception or broadcasts of code, or for experimental purposes, the NATIONAL SW-5 THRILL-BOX is recommended.

READ WHAT USERS SAY:

"Truly a masterpiece in the SW field." . . . "No comparison possible with other receivers." . . . "Works perfectly and surely brings in the DX." . . . "Have had years of experience and I have never seen a receiver that nearly approaches the NATIONAL SW-5 THRILL-BOX in performance." . . . "5 continents and 23 countries received." . . . "They don't make SW Receivers better than the NATIONAL SW-5." (Names on request.)

HIGHLIGHTS ON THE SW-5

Range 9-2000 meters. Extremely high signal to noise ratio. True single-knob tuning. Set and forget the antenna trimmer. Easy to log with NATIONAL projector Dial, type H, no parallax. Special 270° Type S.E. Tuning Condenser with insulated main-bearing and constant-impedance pig-tail makes gang-tuning possible on the short waves. Equipped with standard set of 4 pairs of R.F. Transformers covering range of 15 to 115 meters wound on forms of genuine NATIONAL R-39. Uses the new UX-235 Variable-Mu Tubes, giving improved sensitivity and less critical operation. Humless A.C. Power Supply with special filter section. R.F. Filter on Rectifier Tube, and Electrostatic shield. R.C.A. Licensed. Made also in low drain battery model.



NATIONAL NC-5 SHORT WAVE CONVERTER

NATIONAL SW-5 A.C. & D.C. THRILL-BOX

Send this COUPON in today

NATIONAL COMPANY, INC., 61 Sherman Street, Malden, Mass.

Gentlemen:

(Check which)

- Please send me complete information and prices on your new NATIONAL NC-5 Converter.
- Please send catalog sheets on the improved SW-5 THRILL-BOX.
- I enclose 50c (stamps or coin) for your 64-page Handbook of Short-Wave Radio, describing in full the latest and best short-wave receiving circuits, adapters, converters, meters, etc.

Name

Address

SWC-2-32

You Want to Earn More Money—You Want to Be Sure of Steady Employment—You Want to Be Certain of Your Future—Here Then Is the Opportunity You Have Waited For.



Start Now — Learn

Here is a Blazing Message, to Real, Red-Blooded He-Men

"Broadcasting stations use engineers, operators and maintenance men, and pay \$40 to \$100 a week and up. Manufacturers, jobbers and dealers employ thousands of men as engineers, foremen, inspectors, testers, service men, salesmen and managers, and pay \$40 to \$150 and \$200 a week. Sound picture concerns and public address systems use engineers, installation and maintenance experts, etc., and pay \$40 to \$200 a week and up. Manufacturers of photo-electric cell equipment (Radio's electric eye) use designers, adaptation engineers, installation men and salesmen, at \$40 to \$200 a week and up. Steamship companies employ hundreds of Radio operators, give world-wide travel, at salaries of \$85 to \$200 a month and all expenses."

RADIO

TELEVISION
TALKING PICTURES
SOUND SYSTEM
PHOTO CELL WORK

AT HOME—and Get Into the World's Fastest Growing and Best Paying Industry.

Why then, should you slave away at \$20 or \$25 or \$30 a week, on a back-breaking no-future job, when Radio offers such wonderful opportunities for good pay and advancement?

Never before has such a chance been available to the average working man. It's an opportunity that is open to every normal, ambitious man—regardless of age, schooling or experience, who is willing to spend 30 minutes a day or more, for a few months, in learning the theory and practical application of all Radio devices.

You will be taught at home, under the actual supervision of a group of Radio executives and engineers, with a course of practical and up-to-date training, endorsed by sixteen of the largest and most progressive Radio manufacturers, among whom are—BRUNSWICK, CROSLLEY, FADA, PHILCO, MAJESTIC, STROMBERG-CARLSON AND ZENITH.

Where only hundreds of men were employed in Radio a few years ago thousands are employed today. Where only a hundred jobs paid \$50 to \$75 a week a few years ago, there are thousands of such jobs today, and there will be thousands more for trained men in the next few years.

If you are interested in bettering your position—if you want to get out of a small-pay, no-future job, into good-pay, big-future work—fill in the coupon below and mail it at once, as men are being enrolled for this training now. There will be no obligation. And it will certainly pay you to investigate.

FREE OPPORTUNITY BOOK COUPON

RADIO AND TELEVISION INSTITUTE,
Dept. 1072, 2130 Lawrence Ave., Chicago.

Please send me a copy of your Opportunity Book and full particulars of your plan for helping men into good pay positions in the Radio field.

Name

Address

City..... State.....

Free

Every Manufacturer, Dealer, Distributor, Serviceman should have on file the New, 1932 Edition of the

CLAROSTAT

CONTROL HANDBOOK and CATALOG

containing complete specifications on Clarostat Variable Resistors, Volume Controls, Tone Controls, and Voltage Controls together with complete information on their use in experimental, service and replacement work.

Write Dept. S.W.C. for Your Copy

CLAROSTAT MFG. CO., Inc.
285-N. 6th Street Brooklyn, N. Y.

A First Class "Ham" Station

(Continued from preceding page)

occurs with the condenser at minimum, add a turn or two; until the drop in plate current occurs at a frequency just at the top of the band on which the coil is to be used. This coil acts as a choke in the power amplifier and, when this stage is used as an oscillator, L4 is simply the resonant grid coil in a tuned-plate, untuned-grid (or "TNT") circuit.

For 3.5-megacycle work, the two excitation clips leading to the grid of the last stage are connected to opposite ends of the oscillator inductance, and both doubler tubes are removed from their sockets. Of course the proper coils are inserted at L4 and L5. Care must be exercised when operating on the same frequency as the crystal's fundamental to see that the amplifier is properly neutralized before the plate voltage is applied. With the simplicity of a push-pull circuit and its ease of neutralization, this hazard is greatly reduced.

For fourteen-megacycle work, both doublers are used, with number two feeding the power amplifier. Great success has been had with this particular transmitter on 14,120 kilocycles. The second station worked was a Chilean; and the third was G6CO in London, England, in mid-afternoon—certainly not an everyday feat with W9DFR's location. The antenna system used for this twenty-meter DX is a zeppelin voltage-feed system, consisting of a single wire thirty-two feet long and fed by two fifteen feet feeders spaced six inches apart. The antenna is located indoors in a second-story room and is made of No. 22 wire; however a larger gauge is recommended.

For Phone Hounds—A Modulator Unit and Speech Amplifier

The modulator unit and speech amplifier are rather compact and built into a single unit. The diagram is self-explanatory; but a few words are added here for the benefit of the builder who has never used phone and is not acquainted with the constant-current modulation system.

A separate filament transformer is used—for no good reason except that there were no available windings on the main filament transformer.

The microphone used must be a "high-level" mike; an ordinary telephone transmitter will serve the purpose. If a two-button, or condenser, or any of the lower-level microphones is used, it will be necessary to add at least one more stage to the speech amplifier in order to obtain anything like 90% modulation of the carrier.

The microphone's input transformer has a primary impedance around 200 ohms and a secondary impedance of 25,000 ohms. T2 may be any of the better-insulated audio transformers, with a ratio around 6 to 1. The modulation choke T1 must be insulated for the full plate voltage, and be capable of handling 150 milliamperes continuously without overloading. R1 drops the voltage on the power amplifier, so that a higher modulation factor is obtained. Remember that this unit is cut to the very minimum and every part that is in the diagram is necessary for satisfactory performance.

The "C" battery may be common for the radio-frequency stages.

It may be necessary to add another four microfarads or so of capacity to the output of the power pack's filter, in order to entirely eliminate the hum from the

carrier. All A.C. filament leads should be twisted, to prevent hum from entering through this source.

The bias on the power amplifier should be increased to 90 volts, when it is used for phone transmission, and the excitation reduced until the antenna current is only one-half maximum. This last is accomplished most conveniently by reducing the plate voltage, on the doubler stage, with the variable resistor in the plate lead. It is well to remember that, under the present regulations, only the 160-meter band and 3,500 to 3,550 kilocycles are allotted to the phone men. The 20-meter band may be used, however, if you first obtain permission from your radio supervisor.

View From Right Side (Photo) Description

TOP SHELF:

On the panel are seen the two antenna tuning condensers with the two 3-plate neutralizing condensers immediately below and the plate

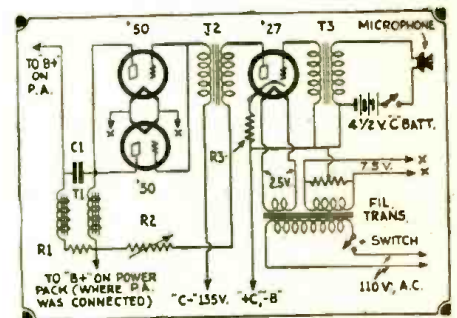

Modulator Unit: C—1 mf., 1,000-volt condenser. R1—1,500-ohm resistor that will pass 200 M.A. R2—Variable resistor (Clarostat) to cut voltage to 180 on '27 plate. R3—2,000-ohm fixed resistor. T1—Double section 30 henry choke—each section should pass 150 M.A. T2—Audio transformer 5 to 1 or 6 to 1 ratio. T3—Microphone "input" transformer.

milliammeter in the center. The dial (which is tuned from this side) is the tank circuit of the last or push-pull stage. The tank coil is to the left of this dial and has an antenna coil mounted on each side. To the right of the tank condenser or dial, one of the power amplifier 210 tubes may be seen, the other being obscured by the corner post. The grid coil is also obscured but its location is between the two 210 tubes and to the right. The binding post strip is attached to the rear. On the bottom of this shelf the switches S1 and S2 are mounted.

SECOND SHELF FROM TOP:

The 210 closest to the reader, and also on the left, is the oscillator tube. The coil to the left is the tank coil which is plug-in and the condenser mounted on the panel at the left is the tank tuning condenser. Immediately below this condenser the plug-in crystal is mounted, arrangement being made for plug-in choke in case crystal is not used. The 210 tube in the center is the first frequency doubler which has the same tank circuit arrangement except that the tank coil is at right angles to the oscillator. The 210 tube to the right in this group of three is the second doubler which is also similar except that the plate coil is again turned at right angles to that of the adjacent stage. There is another stage which is used experimentally on ten meters partly visible to the rear or right of these three stages; however, it is not in use at present.

THIRD SHELF FROM TOP:

On the panel are mounted the voltmeters with the resistor for the high voltage meter and the power switches. The "C" batteries are

used for bias and to their right is the modulator unit using one 227 and two UX-250 tubes. A row of binding posts is mounted at the rear and to the top of this shelf. The filament transformer for all tubes is back of the "C" batteries and is not visible. The voltage drop resistors are mounted upright on the leg which is at the extreme right.

BOTTOM SHELF:

Filter condenser at the extreme left with the rectifier tubes visible behind it. To the right of the filter condenser is the double filter choke and to its right is the square D cut-out fuse box. To the rear of the fuse box are two more filter condensers and back of them is the high voltage transformer. The 110-volt AC line is trailing.

Circuit of New Pilot All-Wave Receiver

(Continued from page 335)

gain power as evening draws on. Both stations have been picked up with sufficient volume to overload the broadcast section of the set.

"Plenty to Hear"

On the third band the main source of interest is the American broadcast channel around 49 meters. Here reception is usually excellent with stations several hundred miles away coming in with as much strength as local broadcast stations. We have also picked up Canadian stations across the continent with good volume. The Vatican City station is located about 50 meters and can be picked up on the third band.

The range from 65 to 110 meters includes a host of interesting things—airplanes, police reports, which are highly exciting, and amateur phones, which are usually a lot of fun. The fifth band has more amateur phones, several police broadcast stations and a number of television stations.

The "All-Wave" in its handsome table model cabinet is an ideal radio receiver for any home, and will provide thrills and enjoyment for every member of the family. It is supplied only in complete factory-built form, all ready for use. It is not sold in kit form, nor are the parts available separately.

The short-wave converter unit alone will be sold in a small cabinet for people who have good broadcast receivers and who want to enjoy foreign reception without going to the expense and trouble of obtaining a complete short-wave set. This converter, containing its own power supply, may be used in conjunction with any neutrodyne, T.R.F., or super-heterodyne receiver.

The broadcast set is simply adjusted to 550 kc., which is at the high end of the scale. All short-wave tuning is then done with the single selector dial on the converter, and the volume is regulated by means of the regular volume control on the broadcast outfit. Nothing could be easier.—*Radio Design.*

ROYAL

SHORT WAVE TRANSMITTER RECEIVER, AND POWER SUPPLY KITS AND SETS

Takes the guesswork out of home construction! Every part needed down to the last nut is included. Complete construction and operating instructions in simple terms, easily understood by anyone. These scientifically designed kits use the highest grade parts throughout to obtain maximum results. Also supplied AWT (Assembled, Wired and Tested).

SHORT WAVE RECEIVERS

For reception (from foreign countries as well as U.S.) of broadcasting, code, airplane reports, television signals, ship conversations, police transmitters and others. All necessary parts including drilled panel and complete instructions. Micro-vernier dial makes close tuning easy. These sets are guaranteed to give better results than any others. Tunes 14 to 200 meters. (550 Meter coil 75c additional.) Also supplied in special "Ham" type with the 20, 40, and 80 meter bands widely spread. State choice when ordering.

Model R1—A sensitive one-tube receiver with a world-wide range! Special refinements make this set superior to any other. AWT, \$9.25. Kit, \$5.95.

Model R2—Same as R1 but with a stage of quality audio amplification to increase the volume. AWT, \$11.65. Kit, \$7.75.

Model R3—Same as R1 but with two stages of quality audio amplification for loud speaker reception. Has special volume control and provision for C bias if power tube is used. THE BEST. AWT, \$13.75. Kit, \$9.25.

(Neat bakelite form plug-in coils are used instead of large sloppy coils with wire leads that are easily broken! Best results!)

SPECIAL!

SPECIAL!

SPECIAL!

The latest ROYAL Short Wave Receiver is a positive knock-out! Uses a 232 two-volt screen grid and a 233 Pentode tube. This combination in a perfected circuit gives amazing volume with extreme sensitivity! Loud speaker reception of many stations is possible. Needs only two dry cells, a 3 volt C battery, and three 15 volt B batteries. Guaranteed to out-perform many higher priced sets! Model RP—\$13.95. Also in KIT form for those who like to "Roll their own". Complete with all necessary parts including instructions, \$9.95.

TRANSMITTERS

You can work these transmitters with dry cell tubes with batteries, up through receiver tubes with "D" Eliminators, to a real 210 power tube with one of our high-power transmitting power supplies and obtain amazing results all the way. Heavy copper tubing inductance, good quality variable condensers (add \$1.90 each if you wish Cardwell Condensers), heavy transmitting grid leak, special choke, large porcelain stand-off insulators, resonance indicator, socket, condensers, dials, hook-up wire, etc., make these transmitters the finest money can buy! Puts out a strong, steady signal that will carry all over the world. Get "On the Air" NOW with a real outfit and experience a new thrill! Inductance supplied for 40 meter band. All models will work on two bands, but maximum results can be obtained only on the band for which it is designed. 80 meter band 50c extra. Readrite meter 80c extra. Jewell \$5.00. (Meter not necessary for operation.)



ROYAL MODEL TP-P

For UX-210 Tubes and all others. AWT, \$15.25. Kit, \$9.75.
SPECIAL LOW POWER TRANSMITTER. Completely wired and tested! All you do is plug in tube and start sending. Uses any receiving tube. Complete with meter and resonance indicator.
Model TC, \$9.95.

TRANSMITTING POWER SUPPLIES

These well filtered units will give your transmitter a pure DC note with a "Wallop" behind it! Contains heavy duty power transformer, large choke, high voltage condensers, sockets, cord and plug, etc. Delivers both filament and plate voltages. All operate from 110 volt 60 cycle AC house line.

Model PA—Uses one 280 tube. Output is 300 volts DC at 50 MA. 7/8 volts at 2 amp. (easily cut to 5 or 2 1/2 V.). AWT, \$6.45. Kit, \$4.50.

Model PB—Uses one 280 tube. Output is 350 volts DC at 100 MA. 2 1/2 V. CT—2A, 2 1/2 V. CT—3A. AWT, \$10.95. Kit, \$7.95.

Model PD—Uses two 281 tubes. Output is 500 volts DC at 125 MA. 7 1/2 V. VT—2 1/2 A, 2 1/2 V. CT—12A. AWT, \$15.95. Kit, \$10.95.

Model PE—Uses two 281 tubes. Output is 650 volts DC at 170 MA. 7 1/2 V. CT—2 1/2 A. AWT, \$17.95. Kit, \$12.95.

MANY OTHER MODELS AND COMPLETE LINE OF TRANSMITTING AND RECEIVING APPARATUS IN OUR FREE BARGAIN BULLETIN

Send for it now!

SHORT WAVE ACCESSORIES

To insure the maximum results from your receiver and transmitter we advise the use of our SPECIAL SHORT-WAVE TUBES. Every one is tested in a short-wave receiver or transmitter. RCA Licensed. Free replacement for 15 days. UX-201A, 40c. UX-199, 95c. UX-210, \$2.95. UX-230, 231, 237, 85c. UX-232, 233, 235, 236, 238, \$1.10. UX-243, 55c. UX-217, \$1.20. UX-250, \$2.05. UX-280, 60c. UX-281, \$2.45. UX-866, \$4.50.

Sensitive 2,000 Ohm headsets, \$1.40. Baldwin Loud Speaker Units, \$1.45. Phone Plugs, 25c. Antenna Kits, 95c. High grade Batteries: Dry Cells, 35c. 1 1/2 Volt C, 35c. 2 1/2 Volt C, 85c. 45 Volt Standard B, \$1.40.

CODE PRACTICE SET—Uses a UX-199 Tube and two dry cells. Produces a pleasing, smooth note in the phones, that is easy to copy. Completely assembled, \$1.95. Signal Key, \$1.65.

QUICK DELIVERY ON ANY RADIO PART.

All of our Short Wave Apparatus is designed by Government licensed short wave operators with a vast experience in this field.

20% DEPOSIT REQUIRED WITH ALL ORDERS.

Foreign Orders should contain full remittance plus transportation.

Harrison Radio Company

189 Franklin Street Dept. C-5 New York City

TRANSMITTING SETS

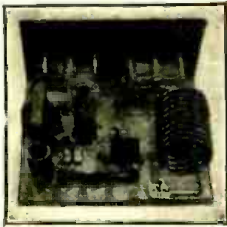

We have the latest and best! The sets have heavy copper tubing coils already wound (for 80- and 40-meter bands; 20-meter coil, 30c extra), best variable condensers, special transmitting choke and heavy-duty gridleak, fixed condensers, sockets, dials, good panel and sub-panel, hookup wire, all hardware, etc.

Everything you need to build the set complete. Transmits all around the world! Latest Circuits! FULL INSTRUCTIONS, with numerous hookups of rectifiers, filters, power supplies, transmitting aeri- als, etc., etc. Sets will work with dry-cell tubes and batteries (range 500 to 1000 miles on low power) at first, or larger tubes up to a 210, or even 2, 210's or '45 tubes in parallel! (50 watts!) Hook-ups supplied so you can use AC tubes (no batteries!), if desired. Attachment for 'phone transmission, \$1 extra. Plate Meter, 80c extra (though not necessary for operation). Get a good-looking panel-mounted set that looks business-like. MODEL A TRANSMITTER: Single-Control Transmitter. Works on either 40 or 80 meters without changing coils! (This feature alone heats any other set!) Uses famous T.P.T.G. circuit. A neat panel-mounted job. Kit, \$6.00. Same set for base-board mounting, \$5.50. MODEL B TRANSMITTER: Uses Hartley Circuit. Famous all over the World. Kit, \$6.70. We will ship either of above sets already assembled and tested for \$5 extra for shop work. Nickeled Hand "Mike" with special hard rubber handle, \$5.95. Filament transformer for AC operation, \$3.25. Type '45 transmitting Tubes, \$1.40. Fine transmitting keys, \$2.25. No license necessary to use one of these sets, so long as no transmitting aerial is used!!

Delft All Short Wave Wavemeter

This wavemeter is simple to use and saves time in tuning in foreign stations. Look up the wavelength of station wanted, set wavemeter to this wavelength (marked on wavemeter dial), then tune receiver to the wavemeter. Any station easy to find. Not connected to set in any way, just brought near it. Nothing else needed to use it with your set. Tune up 11 to 250 meters so any station can be found. Accurate. Shielded. Calibration remains constant. Numerous other uses: Checking receivers, coil and condenser ranges, transmitters, etc. Absolute necessity to experimenters. Use it to demonstrate your sets. Works with any short-wave regenerative receiver like DELFT, Pilot, S.M. National, etc., etc. Works with battery or electric sets alike. Also works with adapters. Complete Wavemeter with plug-in coils, large accurate calibration chart and FULL INSTRUCTIONS. List Price \$15. Your Special Price Postpaid, \$9.95. Jobbers and dealers see us. We can also supply a cheaper wavemeter, not quite as accurate. Has plain dial, wooden cabinet. Range 15-120 meters. Complete with chart, \$3.95. HAM-BAND Wavemeter. Looks like above meter. 1/4 of 1% accuracy. With calibrated coil for any one Ham band, \$6.95. For each extra band desired, add \$2.00.

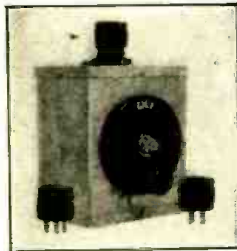

COIL WINDING SET



Makes latest low-loss accurately-spaced short-wave coils. Set includes special, collapsible, accurate, turn-spacing coil-winding form and all necessary forms, etc., for making these coils more can buy! Also FULL INSTRUCTIONS showing all coil and condenser sizes for any short wave. Nothing else to buy. Complete, \$1.89 Postpaid. Short-Wave Tuning Condenser (.00015 mfd.) \$1.35. Regeneration-Control Condensers, \$1.25. SPECIAL!! Coil Set, and above 2 Condensers, \$4.00.

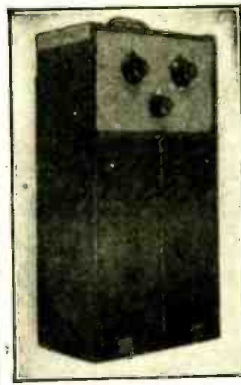

TWO-TUBE PORTABLE SET!!

Here's your Set!! Takes up minimum space, easy to move around. All complete as shown. Gives fine loud headset volume on any short wave. Will also get ordinary broadcast! Light in weight, 1,000 miles on small aerial. Extra slip inside case. Uses 2-coil tubes and PEN-TODE TUBE (works like 3-tube set!). Size: 8" x 18" x 5" deep. Complete Kit (plug-in coils, case - everything!), \$18.00, with tubes. Full Instructions. Set shipped complete, assembled and tested, \$25.00 with tubes. Nothing like it anywhere!!

NEW SHORT WAVE RECEIVERS!! All-Electric or Battery Sets Using Screen-Grid and Pentode Tubes!

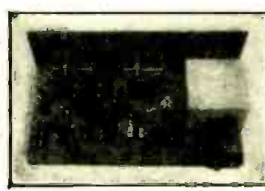

These Modern Short-Wave Receiver Kits use the new pentode tubes!! Remember: a pentode tube costs no more but gives the volume of two ordinary tubes!! The set has to be specially designed to use this tube too! Guaranteed to outperform anything on the market! Brand new and up-to-the-minute, yet the lowest in price on the market! These sets get everything that can be picked up on short waves—broadcasting, U. S. and foreign, code, music, Television, etc., etc. The Kits furnish ALL PARTS, panels, baseboard, all hardware—everything to build the set. You can use any kind of batteries or tubes. AC Kits also listed below. A fine coil winder also furnished so you can make coils to cover any wavelengths at all, as well as any extra coils you may need for R.F. amplifiers, etc. All sets listed below are similar to others. One Tube Receiver with Special Sensitive Circuit. Note: This little set is BETTER than any other because it can be used as a separate one-tube set or as an adapter just the way it is, and also as a superheterodyne converter of the latest design by building a simple oscillator to it. Full Instructions. Kit, \$5.95. AC Kit, \$6.45. Two-Tube Set using new Pentode Kit, \$6.85. AC Kit, \$7.75. Special High-Gain Two-Tube Set. Uses a screen-grid tube, also a pentode. Kit, \$7.45. AC Kit, \$9.45. If you want your set already wired and tested, add \$5.00 to above prices. Three-Tube Set using new Pentode (works speaker). Kit, \$8.35. AC Kit, \$10.35. Assembled, add \$6.00. These sets PERFORM!! Easy to build! You have choice of a complete set of plug-in coils or coil-winding set, with each kit! Four-Tube Sets: Interval, Short-Wave and Television receivers. Four-Tube Kit, \$13.00. AC Kit, \$15.00. Four-Tube Set with tuned input R.F. stage, detector, audio and Pentode in last stage. Kit, \$15.00. AC Kit, \$17.50. (A 4-Tube with a Pentode works like a 5-Tube). Filament Transformer for AC Kits, \$3.25 (will light as high as 7 tubes). New 2-coil dry-cell tubes, \$1.30 each. Fine headphones, pair, \$1.95. AC Tubes, \$1.00 each. Assembly charge on 4-tube sets, \$8.00.

Add Tubes Ahead of Your Present Set and Increase your Distance Thousands of Miles!!



These Sets Can Be Added Ahead of ANY S.W. RECEIVER, A DAPTER OR CONVERTER!

(AC or DC) You get ALL PARTS (Plug-in Coils—everything!). Full Instructions. No New Power Packs or Batteries necessary for any of the sets below because ALL PLATE POWER COMES FROM YOUR PRESENT OUTLET. Easy to assemble. For Light-Socket Operation: (Type '21 s.g. tubes). One-Tube Kit for baseboard mounting (tuned R.F. stage), \$4.95. Same but TUNED R.F. STAGE, also for panel mounting, \$7.95. Two-Tube Kit, \$9.45. For Battery Operation: (Use dry-cell or s.g. tubes type '29), same as above AC Kits, but \$1 less in each case. Filament Transformer for A.C. Kits, \$3.25. Prices, less tubes.

Short Wave Converters

By RICHARD F. SHEA

(Continued from page 327)

a short-wave set, without plug-in coils, lies in the use of some satisfactory form of switch. The great majority of switches at present on the market fall short of the ideal necessary for a satisfactory short-wave switch; so it will be fitting here to go into detail concerning the design of this important device, with con- structional details of a satisfactory unit.

For a switch to be suitable for such work it must, first of all, be positive in contact. No cam-actuated switch, where two members are lightly pressed against each other, will do for this special usage. The contact must be firm, with consider- able tension. Secondly, it must be a wip- ing contact, in order that it may clean itself in use; otherwise there will be a tendency for it to become covered with dirt or to corrode or oxidize. Similar metals should be used, to prevent contact potentials from being developed, and the choice of metals should be such that they will stand up under the most severe cli- matic conditions. The saline atmosphere found in certain Asiatic climates is par- ticularly injurious to most metals used in radio receiver design; and hence special care must be taken in the design of any unit going to such a country.

While pigtail connections are simpler, they present several disadvantages for this particular use. For one thing, any pigtail must have several loops if it is to stand continual twisting; otherwise it will break at the joint with the shaft. However, if there are loops in a pigtail connection, these loops will have a com- paratively high inductance and, worst of all, this inductance will vary with the position of the switch. Since the switch is connected directly in the coil leads of the detector and oscillator circuits, it is obvious that any inductance here will throw off the tuning of these circuits.

Another feature of switch design that must be watched is the capacity between sections. The importance of this will be realized if it is remembered that, through this capacity, we get extraneous coupling between oscillator and detector circuits; the possible undesirable results of this coupling have been stressed in an earlier paragraph.

A very desirable feature of any switch, that is to be used for any such purpose in a short-wave converter, is that the con- tact members be closed against dirt. This may be accomplished by making the blades in duplicate, with the wiping con- tact going between them. If the contacts normally press together, there is slight chance of dirt or any other foreign par- ticles getting in between them.

A Good Short-Wave Switch

Fig. 5 illustrates the construction of a switch which was found satisfactory from all these standpoints. This switch was built up from a number of sections, each consisting of a bakelite block, cut out in the center. Around the edges of this cut-out were riveted pairs of contacts, which normally press together. A wiping blade went between these contacts and made a direct circuit between them and a sector on the other side of the opening. In other words, this switch is a modification of a rotary knife-blade switch, with the con- tacts diagonally opposite each other. Since the switch was direct-connecting,

Get Complete Plans and Descriptions how to make them, of different Radio Prospecting methods. Many pages of diagrams, useful information (By A. Blinnegan), \$2.00. We carry the famous line of SARGENT SHORT-WAVE CONVERTERS AND SUPERHETERODYNE RECEIVERS. Do you want something fine in S.W. Converters? Looks like midsize receiver, contains own power. No messy wires. Best in the country. Price, \$69.95 with tubes. Write for description of this fine line. Used DC Broadcast Receivers, perfect condition, \$5 each. Latest National Time Code-Practice Set. Uses '99 tube, 2 dry cells run it. \$3.85. Tube: \$1.25. 4-Prong S.W. tube-base, plug-in coils, set of 3 (15-125 meters) for .0001, .00014 or .00015 condenser; for detector, \$1.50 for R.F. Amplifier, \$1.25. S-W hook- ups FREE with ea. set of coils. S-W Adapter Kit, AC or DC, \$5.95 Complete. By all means get our low-price catalogue before you buy anything in the Short-Wave Line! Send few stamps for same. We are ultra-short-wave experts! 2% off for cash in full. Foreign Orders cash. If C.O.D., send \$2 Bills or stamps, pay rest to postman when delivered.

DELFT Phone: Higate 0748

DELFT RADIO 524-D Fairbanks Avenue OAKLAND :: CALIFORNIA

SHORT-WAVE AND ULTRA-SHORT-WAVE RADIO SPECIALISTS

no pigtails were necessary, and the dimensions of the parts were kept down to minimize capacity between elements. Phosphor bronze was used throughout, as a material which would stand up best under the severe conditions this switch was likely to encounter. Since the blades were normally pressed together, there was no possibility of dirt getting into the contacts.

Fig. 6 illustrates a similar switch which might be as good as the one of Fig. 5, although it has not as yet been tried. It differs essentially from the other only in that it uses a double wiping blade and single contacts, with the blade wiping on both sides of the contacts. It is much simpler constructionally than the first one, but has the disadvantage that the contacts are exposed to dirt. If the switch is used fairly often, so that the contacts can be cleaned, this objection is probably not serious.

The "Autodyne" Oscillator

Lately we have witnessed the development of broadcast supers using *autodyne* oscillators, making use of the dynatron in an oscillator-detector combination. While the author has had no opportunity to try this system for short-wave work as yet, it theoretically offers a great simplification and other advantages in lessening reaction and reducing the number of tubes necessary. A suggested circuit for the experimenter who wishes to try out this system is shown in Fig. 7. Care must be taken to avoid reaction or coup-

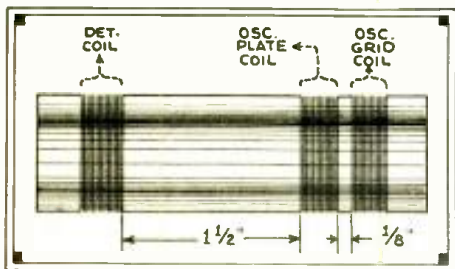

Spacing of coils on tube.

ling between the two high-frequency tuned circuits; or the performance of the device may be impaired, and it may even become a tuned grid-tuned plate oscillator.

Previously, in this article, mention was made of the use of a *bridge* for coupling oscillator and detector circuits. While this is another circuit which has not been tried yet, it too possesses many theoretical advantages; the main one being elimination of reaction. Since the two tuned circuits are across opposite sides of a balanced bridge, they have no effect on each other, and each can be tuned independent of the other. This will not be entirely true if there is any extraneous coupling between these two circuits; consequently all the precautions listed in the paragraph on coupling prevention must be observed.

An All-Wave Converter

Now for constructional details. Fig. 8 gives the schematic of an *all-wave converter* which has been found very satisfactory, although not perfect, when used with a modern broadcast superheterodyne of average sensitivity. As can be seen from the diagram, this converter employs magnetic coupling, with a twogang condenser, and an additional stage

of amplification tuned to 550 kilocycles, and it contains its own "power-pack". The additional stage of amplification is of real advantage, particularly when used with a broadcast set of slightly lower sensitivity than average. With a very sensitive receiver, the "noise level" will be somewhat too high to employ full volume; however reception has been had from all over the world, using an average superheterodyne, so there should be "pep" enough here to satisfy the most critical.

This receiver is a truly all-wave job, employing the switch described previously, thus avoiding plug-in coils. On the sixth position of the switch, the antenna is connected directly to the broadcast receiver, and the grid of the short-wave detector is grounded, to prevent open-grid noises. The condenser is the one described previously, with a double-spaced oscillator condenser, mounted on rubber, and covered with a shield. It will be noticed that individual small fixed condensers are used across each of the oscillator plate coils, to make the two circuits track together. This method, instead of the more common series condenser, reduces the number of switch sections necessary. It will also be noted that the 550-ke. stage is of the capacity-coupled stage. Since we do not need great selectivity here, it is cheaper to use the parts shown, than the more common two-coil, two-condenser unit.

There are several precautions to be observed religiously in the construction of this unit. One is to keep the wiring as short and direct as possible, particularly in the tuned circuits, and between the switch and the coils. It is also recommended that individual ground leads be run as direct as possible from the sections of the variable condenser to their respective switch sections; to avoid common coupling in the frame and ground leads. If long wires are allowed to get in the tuned circuits, they introduce an inductance comparable to that of the smaller coils, and seriously impair the performance of the set. Another thing that must be noted is that the by-pass condenser between "B+" and ground must be connected right at the smallest coil terminals. One of the new roll-type condensers will do very nicely here. Make your ground connections all at one point on the chassis, to avoid common-ground drops. If all these precautions are carried out, there should be no trouble in getting satisfactory service out of this converter.

It might be well here to give a hint on trouble hunting with this converter. The easiest way is to insert a five-milliamp. meter in the "B+" lead of the detector, and a fifteen-milliamp. meter in the "B-" lead of the oscillator. If the oscillator is working correctly, the plate current should be between five and seven milliamperes. If it reads about ten or eleven milliamperes, the tube is not oscillating. The normal plate current for the detector is very low; however, tuning the trimmer condenser should make the plate current go up to over one milliampere. These simple tests will readily show if all the bands are working correctly.

While the foregoing converter is very good as an all-round short wave receiver, occasionally such a job is desired for some special purpose. Another converter which has been built and found very satisfactory for its own limited use is here described. This unit was developed

WOULD YOU LIKE THIS KIND OF WORK!

...learn how at



Studio engineer in great broadcast station

THERE is no more fascinating work than radio. How would you like to become a part of it...like the man pictured above? He is a studio engineer in a large broadcast studio—where millions of dollars worth of programs go out on the air.

You can learn this...and many other interesting branches of radio at RCA Institutes. It is America's oldest radio school, and associated with the largest, most complete research laboratory in the radio industry. What more need you know?

You may study at *resident* schools in New York, Chicago, Philadelphia, Boston. Or study at home through our *extension* courses. Special home laboratory equipment furnished. At completion of either resident or extension courses, outstanding graduates become eligible for free advanced resident school scholarships or free university scholarships.

The equipment in the schools is modern; the instructors, men of practical experience. You may choose the course fitted to your needs. Courses start about every six weeks. Day and evening classes. Tuition rates are moderate. Fill in and mail the coupon today for all the facts!

A Radio Corporation of America Subsidiary

RCA INSTITUTES, INC.
Dept. CS-2, 75 Varick Street, New York, N. Y.

Please send me your General Catalog. I am checking below the phase of radio in which I am particularly interested.

<input type="checkbox"/> Aircraft Radio	<input type="checkbox"/> Disc and Film Recording
<input type="checkbox"/> Broadcast Station or Studio	<input type="checkbox"/> Talking Pictures
<input type="checkbox"/> Television	<input type="checkbox"/> Servicing Home Entertainment Equipment

Name _____
Address _____
Occupation _____ Age _____



Short-Wave Coil Assembly Eliminates Plug-in Coils

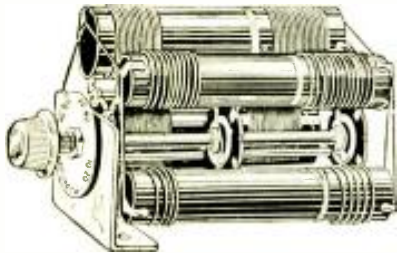

An assembly of four short-wave coils and a low capacity switch eliminating the inconvenience of plug-in coils. Just a turn of the switch enables covering of entire short-wave bands from 10 to 200 meters.

Coils may be readily wired into a superheterodyne short-wave converter circuit for use with a T.R.F. or a superheterodyne broadcast receiver. Complete wiring diagram and instructions for building short-wave converter furnished with each assembly. List price \$12.00.

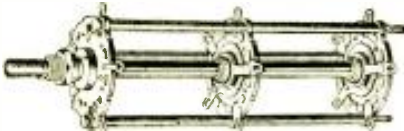

We manufacture anti-capacity band changing switches for use with any short wave coils. Furnished with knob and escutcheon plate showing wave length from 10 to 200 meters. List price \$4.00.

Order from your dealer or mail order house. Send for Circular SW-3 and get full information.

Best Manufacturing Company
1200 Grove Street Irvington, N. J.

specifically for reception of amateur telephone reception on the twenty-meter band, and has a range from 19 to only 23 meters. In principle it is slightly different from the one previously described; as it incorporates two stages of high-frequency amplification and an autodyne detector—oscillator combination. Fig. 9 is the schematic of this converter; it illustrates the method of coupling stages and gives design data. The individual stages are in separate compartments, and isolated as fully as possible. Small midjet condensers are used and ganged up in one shaft, making it essentially a one-dial set. There is a trimmer on the oscillator, but it cannot be used to give vernier action on a signal; its purpose is to keep all the stages in line by tuning the noise to a maximum. Over a wide range it will be found unnecessary to vary this trimmer, and the amateur stations will come in by the manipulation of the main dial only. There are individual trimmers on each stage as well but, once these are adjusted, they need not be touched from one end of the scale to the other.

It might be well to mention here that this type of autodyne detector cannot be used at much higher wavelengths than twenty meters, since the previous high-frequency stage is directly coupled to this detector's grid circuit. If the frequency were much lower, the detector circuit (being 550 kc. away from the incoming signal) would be too far from resonance to deliver much signal to the detector. If such a circuit is to be used at lower frequencies, the detector circuit must be altered to the dynatron circuit of Fig. 7; or else a separate oscillator must be used and coupled to the detector

by one of the methods discussed earlier in this article.

While on the subject of special purpose converters it might be well here to describe a simple unit, which the author has found very satisfactory for 3500-kc. amateur telephone reception. This converter is unusual, I believe, in that it employs regeneration in a rather unusual manner. Fig. 10 shows the connections. From this it is seen that this unit consists of an autodyne detector coupled to a circuit which is tuned to the signal desired. Regeneration is introduced into this tuned circuit by the input circuit of a tube, with a resistance in the cathode lead as the means of coupling between plate and grid circuits of the regenerator tube. A dynatron type of regenerator could probably be used with equal efficiency and greater simplicity. However, this stunt works beautifully, and the regeneration feature greatly boosts sensitivity and selectivity. The fact that this unit could produce intelligible speech at all on the 3500-kc. band is proof enough of its selectivity, as anyone familiar with that chaotic band can well testify.

While there are probably many points which have not been touched in this article, and many more that undoubtedly could stand more detail, still it is felt that this article should lay down a pretty thorough basis for short-wave converter design. It has been attempted to go not too deeply into theory of converter design, but more into practical data, and it is sincerely hoped that this purpose has been accomplished, and that as a result we may see further development along a very interesting line in the future.

Referring to Fig. 8, which is similar to



BYRD
\$215.00

It's Alive! UNICLOK WORLD GLOBE

INVALUABLE FOR SHORT WAVE ENTHUSIASTS

Gives you instantly exact time on any point or city of the world. No more guess-work when listening to foreign and distant stations.

A Scientific Achievement

The illuminated globe rotates daily. The light within the globe revolves yearly placing Earth and Sun in their true positions every minute of the year. It shows accurately: Daylight, Darkness, Sunrise, Sunset, Seasons, Months, Dates, and Correct Time for all the Earth all the time. An unequalled educational instrument which affords an education of our Earth that cannot be had from any other globe. A glance answers all questions of the Earth's rotation, revolution, geography, navigation, travel routes, latitude, longitude, International Date Line, time zones, etc. Schools and educators praise it. A prized possession for every educational institution and short wave operator. An up-to-the-minute beautifully colored hand burnished map mounted on a 12" unbreakable translucent globe synchronized with the famous self-starting Warren Telechron clock. Made in handsomely finished bronze or silver table and floor models.

IN AUTOMATIC MODELS—\$160 to \$265

IN HAND-OPERATED MODELS—\$90 to \$115

Write for complete catalog.

Universal Clock & Globe Corporation

WILMINGTON, DELAWARE



DRAKE
\$160.00

the diagram used for the new Pilot short wave converter, C1—the series antenna condenser, has approximately 10 mmf. capacity. The detector tuning condenser has about 12 to 135 mmf.; the 550 kc. tuning unit has a variable condenser C2—with a capacity of about 5 to 70 mmf., and the coil L1 has an inductance of 2½ millihenries (mh).

This coil is a universal wound affair in the Pilot converter. If the experimenter wished to buy a coil of this kind, he may do so from the F. W. Sickles Co., Springfield, Mass., but if he prefers to wind the coil himself, he may proceed to wind 300 turns 34 or 36 S.S. (or S.S.E.) magnet wire on a wood or fibre spool (scramble fashion), having a core ½ inch in diameter, with ⅜ inch between the bobbin cheeks.

Referring to the short wave converter at Fig. 8, the oscillator plate coils are padded with small capacities, as specified in the drawings, and this may be in the form of small adjustable condensers, such as the X-L or other type, with a lock screw adjustment; they can also be small nidget condensers of the 50 mmf. type adjusted to the values specified. All by-pass condensers such as C3, 4, 5, and 6, are .1 mf. The R.F. chokes have from 10 to 30 mh. inductance and are wound in sections. If you have chokes as high as 70 or 80 mh., you can try them. The voltage divider resistance values are as follows: Starting at the 180 volt end; 4,000 ohms, 1,300 ohms, 5,000 ohms, 700 ohms, "ground". The amplifier cathode resistor has a value of 375 ohms and the

amplifier grid leak R1—500,000 ohms. The other values are given in Fig. 8. The transformer plate supply winding gives 220 volts at 40 ma., each side of the center tap, and the filament winding values are given in the diagram.

All coils were wound on one-inch bakelite tubing. There was about 1½-inch separation between the oscillator plate coil and the detector coil in all cases.

Coil Data

Coil No. 1—Has 3 turns of No. 24DSC wire, wound 14 turns per inch for the detector coil, 2½ turns No. 24DSC wound 14 tpi. (turns per inch) for the oscillator plate coil, and 4 turns No. 28DSC wound 60 tpi. for the grid coil. ¼-inch separation between plate and grid coils on all coils.

Coil No. 2—Has 6 turns No. 24 wound 22 tpi. for the detector, 7 turns No. 24 wound 22 tpi. for the plate coil, and 5 turns No. 28, 60 tpi. grid coil.

Coil No. 3—12 turns No. 24DSC, 40 tpi., detector; 12 turns No. 24DSC, 40 tpi., osc. plate; 12 turns No. 28DSC, 60 tpi., osc. grid.

Coil No. 4—22 turns No. 24DSC, 40 tpi., det.; 22 turns No. 24DSC, 40 tpi., osc. plate; 20 turns No. 28DSC, 60 tpi., osc. grid coil.

Coil No. 5—46 turns No. 28DSC, 60 tpi.; 33 turns No. 28DSC, 60 tpi., osc. plate; 30 turns No. 28DSC, 60 tpi., osc. grid.

The accompanying drawing shows spacing of the coils on the tube.

Inexpensive Phone Transmitters

By A. R. HAIDELL

(Continued from page 325)

wound in place, it will still slip inside the piece of tubing supporting the other coils. The leads to the loop are securely fastened on the inside and connected to a short cord which connects with the hand microphone.

The socket shown for the 50-watt tube consists of two porcelain cleats, and pieces of spring brass which are soldered to the tube pins. These pieces of brass furnish a cushioned socket. (An ordinary socket can be used instead if desired.) The blocking condensers, C1 and C2 in Fig. 2, are of 100-mmf. capacity. The plate blocking condenser, C1, should be of the high-voltage type, to withstand the voltages used, while C2 may be of an ordinary receiving type. The grid leak R, should be 5000 to 10,000 ohms.

The adjustment of the Hartley circuit is as usual. If desired, the main tuning condenser, C, in the oscillating circuit, can be provided with two clips, and adjustments made as shown by the dotted lines connecting with the condenser in Fig. 2. For 80-meter phone operation, the length of the wires used for the antenna are also shown in Fig. 2. No. 12 enameled wire will be found satisfactory for the aerial; the series condenser may be a .00035-mf. The indicator (for determining resonance between the antenna and oscillator circuits) may consist of a small flashlight bulb shunted by a length of No. 14 wire; or it may be a R.F. ammeter of a 0-1 full-scale setting for the low-power tubes, and about a 0-3 scale for tubes of higher power.

The choke coil, RFC1, should be about 150 turns on a piece of cardboard tubing 2 inches in diameter; the exact value of this choke is not usually important. If a centertap is not available on the secondary of the filament transformer, shunt the secondary with a 200-ohm, or so, resistance; and run the center tap lead to the center tap on this resistor.

To operate the telephone transmitter, get it working effectively first as an ordinary code transmitter. The condenser, C, should be .00035-mf. size and adjusted near a maximum setting, so that the frequency transmitted will be very steady. Adjust the set for good frequency stability and fair output to the antenna. With the frequency of the oscillator properly adjusted to the wavelengths allowed for telephone transmission, tune the antenna into resonance with it, by noting when the antenna indicator indicates maximum output. Try keying the transmitter to see that it reproduces both dots and dashes successfully. When properly adjusted for code transmission, insert the microphone loop inside the primary coil and adjust it for best modulation. The correct position may be nearer the grid end of the primary coil.

The plate supply for telephone transmission should be D.C. or else carefully rectified and filtered A.C. A telephone transmitter of low power can be operated from an ordinary "B"-eliminator, for the plate supply, and batteries for the filament.



AMPERITE

Self-Adjusting Line Voltage Control prevents noisy voltage fluctuation in electric radios. Saves tubes—improves tone. Demand AMPERITE when you buy a radio, include it when you build.

For Free Bulletin Write Dept. SW-3



AMPERITE Corporation
501 BROADWAY, NEW YORK
AMPERITE
Self-Adjusting
LINE VOLTAGE CONTROL

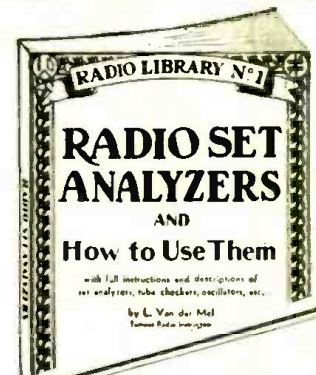

A Timely NEW Radio Publication

JUST OFF PRESS!

If you are a Radio Service Man or if you intend becoming one, this book is absolutely invaluable to you. It goes into every phase of testing and gives you the very information you have been looking for. It contains also complete description and hookups of important analyzers on the market. Fully illustrated with important diagrams, hookups and other illustrations. The only book of its kind in print.

Send fifty cents today for your copy

GERNSBACK PUBLICATIONS, Inc.

98N Park Place New York, N. Y.

Do You Tune or Simply Fish for Short Wave Stations?

INTERNATIONAL SHORT WAVE RADIO NEWS will bring you up-to-date schedules of Short Wave Stations throughout the World for 12 months for only \$1.00, single copy, 10 cents. In addition INTERNATIONAL SHORT WAVE RADIO NEWS will bring you all the important "dope" of happenings in Short Wave Radio everywhere.

Order Your Copies Today

INTERNATIONAL SHORT WAVE RADIO NEWS
Box 22, Boston, 30, Massachusetts
Jamaica Plain Station

PATENT YOUR IDEAS REGISTER YOUR TRADE-MARK BY **Z. H. POLACHEK** 1234 BROADWAY 315, NEW YORK DO IT NOW
REG. PATENT ATTORNEY PROF. ENGINEER
WHAT IS YOUR INVENTION?
Send me a simple sketch or model for CONFIDENTIAL ADVICE

DEALERS — AGENTS WANTED

EVERYWHERE to Handle
the Fastest Selling Radio
Attachment on the Market
Today

THE POLICE LOWWAVE CONVERTER

A new invention that is easily
attached to any radio — by
means of which anyone can tune
in, at any time on local police
broadcasting and get such thrilling—exciting—and
often sensational—items as headquarters talk on
the air for Radio-Police squads. Simple instruc-
tions are furnished.

SELLS FOR ONLY \$3.00
Send \$1.79 for sample, no stamps. Or if you wish,
send 10c in stamps for C.O.D. order and pay post-
man the balance of \$1.69.

POLICE LOWWAVE LABORATORIES
1480 Huron St. Dept. I Toledo, Ohio



WIRELESS or WIRE TELEGRAPHY

Everything Need-
ed to Acquire
Either or Both
Codes

Code Transmitter
10 Rolls of Tape
(2,000 ft. mtr.)
Complete Book of
Instruction.

(Both Codes)
Extra Tapes
Write for Details



INSTRUCTOGRAPH CO.,
912 Lakeside Place

Dept. SW-3
Chicago, Ill.

THE ONLY WAY

To be sure you won't miss an
important article is to subscribe to
SHORT WAVE CRAFT

GRAPH- OMOTOR

The efficient elec-
tric phonograph
motor—absolute-
ly noiseless—no
brushes or auto-
matic switch to cause interference—Speed
1,500 R.P.M. 110 volts—A.C. current—
power consumption 20 watts—reduction
gears—speed controllable 90 to 70 R.P.M.
—finish black enamel—exceptionally low
price. Order direct from



SIGNAL

MENOMINEE

MICHIGAN

Space Doesn't Permit—So we
can't tell you all we would like to about the
"HAWK" THE SENSATIONAL
SHORT WAVE RECEIVER
Embodying latest design practices—Screen Grid B.F.
—Screen Grid Detector—Pentode Audio. Full spread-
ing facilities for "ham" and broadcast bands. Works
loud speaker with tremendous volume.
Priced sensationally low—only..... **\$22 net**
You are invited to drop in to see and hear this
outstanding receiver value

A Complete
Line of Stan-
dard and
"Ham" Parts
Get "H" Parts

Gross

International
Headquarters
for Short
Wave Parts.

25 WARREN STREET, NEW YORK

All-Electric, Single Dial Super-Het

By K. KONIG

(Continued from page 334)

part of an automatic switching device AU which, on the opening of the cover, cuts off the A.C. supply current. The device consists of two springs "f." The two A.C. leads are connected fast to the set. One wire "a" leads over the radio-frequency choke HF4 to a connection of the condenser C15, and from here over the automatic switching device and the switch A-E, to terminal O, of the A.C. transformer; the other wire "b" leads via the radio-frequency choke HF5 and condenser C16 to the primary terminals of the power transformer. The side walls are fastened to the bottom plate by screws, and the right wall is connected with the back wall by bolts. After making the rest of the connections, the A.C. power unit can be mounted together with the receiver section. For the purpose the side walls were screwed by the bent flanges (Fig. 2) to the front panel, likewise the left side wall to the baseboard of the receiver chassis by the angle strips WS (Figs. 4 and 5).

Operation

After putting in an oscillator coil, the safety devices S and S1, the tubes, and connecting the flexible wires with the plates of screen-grid tubes 1 and 3, we can begin testing the set. Since we still must adjust the filter, the blocking circuit, and the potentiometer, we cannot at first close the lid of the case. Therefore we bridge the two springs of the automatic switching device AU by a metal connection, since otherwise the path of the current is broken. Before we connect the A.C. by switch A-E, we set resistor R7 at its greatest value. After turning on the A.C., wait a few minutes, until the electrolytic condensers have been fully charged. Then reduce the resistance of R7, by slowly turning the knob until the voltmeter shows the necessary heater potential. In the future the adjustment of R7 remains unchanged, assuming that the tubes in the receiver remain the same as those for which the adjustment of the heater current potential was made. Switching the set "on" or "off" is henceforth therefore limited to using switch A-E. *Note well!* During the operation no tube must be taken out, say to exchange it for another! For the reduced current would

result in a slight drop in potential and accordingly in a higher current, which might damage the tubes. Changing tubes must therefore be done always with the A.C. shut off. Before turning on the current again, the resistance of R7 is again to be set at a greater value, in order to regulate the heater potential again in the manner before explained, after closing the A.C. circuit.

After the final adjustment of the heater current and the connecting of the antenna and the loud speaker, the adjustment of the filter, the blocking circuit, and the potentiometer can now be effected. The potentiometer is not provided with a knob, but the shaft has a notch; so that adjustment can be made by a long screwdriver. One puts the two rotary knobs of the blocking circuit and the filter and the shaft of the potentiometer first at mean value (center), and seeks a station by very slowly turning the tuning condenser. Afterwards, the blocking circuit, filter, and potentiometer are regulated by ear to greatest sensitivity or loudness and clearness. Necessarily the plate potentials are also to be regulated, by changing the connection on the potentiometer and by changing the values of R2 and R4. If preferred, build in a potentiometer, instead of R2, as shown in the extra part of Fig. 1, in the first part of this article. The total potential can be changed by R6. As a rule I do not use a ground wire; while as antenna I use a piece of "high-frequency" (Litz) 20 to 30 feet long, running from the set across a chest.

Of phone stations, I hear Rome by far the best, in this place (Celle, in the district of Hannover, Germany). With the antenna mentioned, the station appears in the loud speaker (dynamic) very powerfully. On the wavelength of 80 meters, the station appears when the rotor of the tuning condenser is turned in almost to the limit, at a dial reading of 91 on coil 4; when using coil 5, the rotor is turned out almost entirely, the dial reading 3. Since, after proper adjustment of the blocking circuit, filter, and potentiometer, nothing has to be operated but tuning condenser C3, tuning for stations offers no difficulties. The set therefore actually operates on a "single dial."—*Funk Bastler.*)

Keying With New Vacuum Contact

By HERMAN KOTT

(Continued from page 331)

overs frequently experienced with ordinary contacts working at high speed. The signals obtained with this form of keying are exceptionally clean-cut.

There are other ways of applying the Burgess vacuum contact. For instance, the device may be employed in remote keying. By using a flexible cable or

Bowden wire (such as used in operating camera shutters) the contact may be operated at a distance. Again, applied to the ordinary telephone-type relay, the vacuum contact serves as a power relay for remote control, handling a load of over 1,300 watts instead of the few watts handled by the usual relay contacts.

Sliders Do the Trick

By NELSON G. HAAS

(Continued from page 316)

considerable experimenting, that the main trouble when a good condenser fails to give satisfaction after being torn down, is the presence of the "shorted turn" composed of the metal end plates, the metal tie bars and the shaft. The resistance of the joint at the bearings was constantly changing as the condenser was turned and probably was never the same even at the same dial setting. The breaking up of this "shorted turn", by the elimination of metallic tie bars, helped considerably in tuning at the higher frequencies. All connections were made to the rear plate and the front plate was allowed to "float" electrically from the shaft. The fixed capacity between the metallic end plates and the stationary plates was lowered by cutting away all unnecessary portions of the end plates; and no further trouble was experienced. No trouble was found due to the front plate being grounded only through the variable resistance of the shaft bearings; all hand capacity being eliminated by the use of a short bakelite extension shaft and a grounded metal dial.

In rebuilding a condenser for short waves, it is a good idea to go over the finished article with a fine file and emery paper and round off all the sharp edges and, if possible, the plates should be polished.

Avoid the use of condensers which have plates pressed into slots in a spacing bar—if this type must be used, each plate should be carefully soldered to the bar. The type using washers as spacers with strong clamping bolts are perhaps best; although the style using the plates cast as one unit are also very good. Such plates may be cut off with a fine bladed hack-saw and the rough edges filed down and polished; these condensers generally have quite thick plates and they are much to be desired for short wave work.

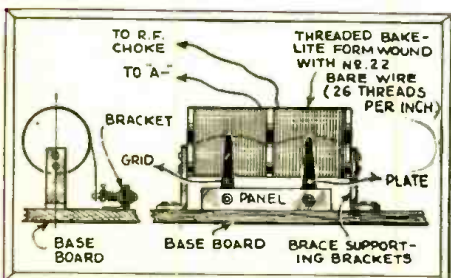
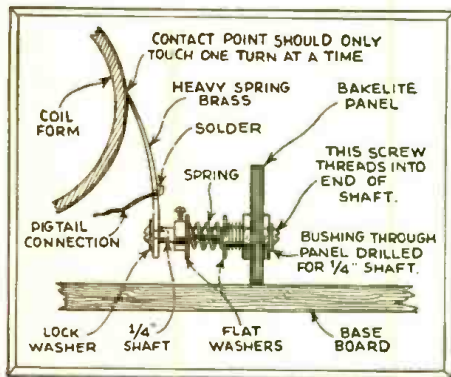

Details of slider-type coils used successfully by the author.

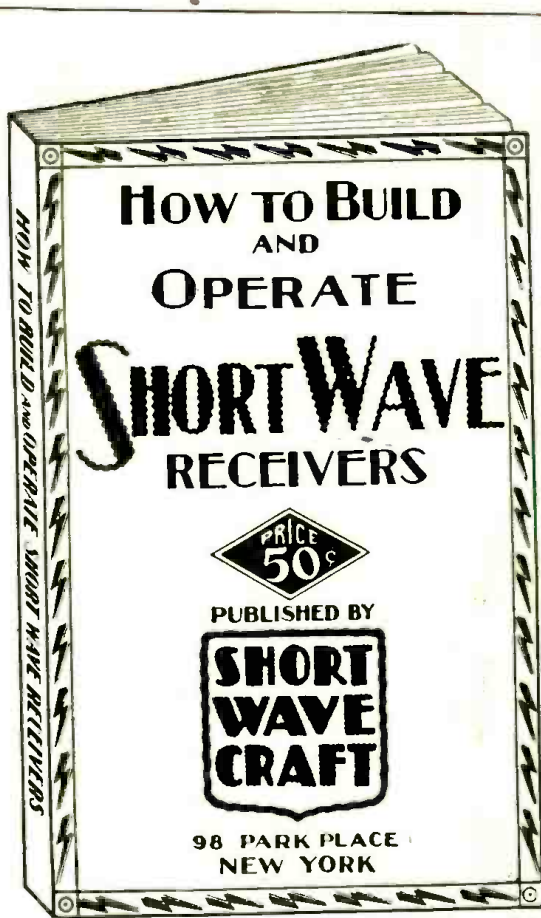

72 Pages
250 Illustrations

50c the Copy

OUT

January 15th

HOW TO BUILD AND OPERATE SHORT WAVE RECEIVERS is the largest and most up-to-date book on the subject that has ever been published.

The book has been edited and prepared by the editors of SHORT WAVE CRAFT, and contains a wealth of material on the building and operation, not only of typical short wave receivers, but short wave converters as well.

Dozens of short wave sets to be built will be found in this book, supplemented by hundreds of illustrations; actual photographs of sets built, hook-ups and diagrams galore.

WE SAY—AND REPEAT IT—THAT NOTHING LIKE THIS HAS EVER BEEN PUBLISHED BEFORE.

We could easily wax enthusiastic about this book, but we prefer to let you be the

judge, and we know in advance from the letters that we will receive, that this is the ONE book short wave enthusiasts have been looking forward to for a long time.

We know that if you are at all interested in short waves you will not wish to do without this book. It is a most important and timely new radio publication.

Partial List of Contents

- The "S. W. C." Two Tube Portable Works "Speaker"—Clyde Fitch
- How to Operate a Short Wave Receiver
- Two-Volt Tube Receiver
- A "Plug-less" S. W. Receiver—John M. Avery
- "My Favorite" Short Wave Receiver—F. H. Schnell
- The HY-7B Super-Het for A.C. Operation—L. W. Hatry
- The "Egert" SWS-9 Super-Het—How to Make It—Joseph I. Heller
- A Super Sensitive Short Wave Receiver—Thomas A. Marshall
- A S. W. Power Amplifier—H. Winfield Secor.
- How to Obtain Smooth Regeneration in S. W. Receivers—"Bob" Hertzberg
- Combination Long and Short Waver—E. T. Somerset, G2DT.
- Super Regenerative Receivers
- How to Build the S. W. Superregenod—Clifford E. Denton
- Short Wave Tuning Less Plug-in Coils—Herman Bernard
- How to Use Radio Frequency Chokes—R. William Tanner, W8AD
- The "Ham's Own" Receiver—Norman B. Krim
- How to Use a Separate Regeneration Tube—E. T. Somerset
- Short Wave Converters—How to Build Various Types
- A Short Wave "Fun Box"
- How to Build a Good Television Receiver—R. William Tanner

MAIL COUPON TODAY!

SHORT WAVE CRAFT
96-98 Park Place,
New York City. SWC-2-5

Gentlemen:—
I enclose herewith fifty (50c) cents for which please send me upon publication, a copy of your new book, HOW TO BUILD AND OPERATE SHORT WAVE RECEIVERS. (Send money order, check, cash, or new U. S. Stamps. Register letter if it contains currency or stamps.)

Name

Address

City and State

Not Sold on Newsstands



SERVICE MEN
SEND for THIS BOOK
YOU NEED IT
FREE!

1932 PRICE GUIDE
Radio Supplies—Tubes—Sets
Every item you require in your business is in this book, from the finest high grade mike to the smallest screw.
GUARANTEED QUALITY GOODS
Prices Lowest Ever Quoted
Fresh new dependable Merchandise at Bargain Prices!
Leading Manufacturers Lines Complete
Send For Your Copy Now!
SAMPLE BUYS FROM THIS BOOK

		
\$14.65	\$1.98	69.
4-Tube Receiver	Replacement Transformer	500V-8M Dry Cond.
and Three Thousand Other Bargains		

HEADQUARTERS for SERVICE MEN'S SUPPLIES

601 W. RANDOLPH ST. CHICAGO, ILL.
USE THIS CONVENIENT COUPON

Radolek Co.,
104 Canal Station
Chicago, Ill.
Please send me without obligation your Service Man's Supply Book.
Name _____
Address _____
City _____ State _____

Aluminum Box Shields
Beautiful Silver Dip Finish

5 x 5 x 5 Knocked-down Coil Shield (like pictured on right)	1.00
5 x 9 x 6	\$1.87
6 x 10 x 7 Monitor Size...	3.25



We make any size to order. Alcoa Shield Plate, 25c.

"Buddy" Test Prods
Always sharp pointed, using phonograph needles, 4 ft. wires, spade or phone tips. Colored nipples identify each lead.
75c each. \$1.50 per pair.
WE SPECIALIZE IN RADIO PARTS EXCLUSIVELY — parts furnished for any kit in any magazine.

National New 3" Vernier Dial	\$1.14
Pilot Coil Forms.....	.35
Hammarlund 80-mmfd. Condenser15
BEST Converter Cabinet. 3.45	
BEST Converter Coil Assembly	7.95
Sponge Rubber Phone Cushions50c pair

Short wave coils, \$1.75
Please include sufficient postage

BLAN, The RADIO MAN, Inc.
Dept. SWC 132
89 CORTLANDT ST. NEW YORK, N. Y.

SWAPPERS

SWAPPERS are swappers of correspondence. During the past few years we have noted that Short-Wave enthusiasts love to get acquainted with each other by mail in order to swap experiences. Use a postcard only. Never write a letter. Address postcard as follows:

SWAPPERS
c/o SHORT WAVE CRAFT
96-98 PARK PLACE
NEW YORK, N. Y.

On the blank side of the postal PRINT clearly your name, address, city and State. Don't write anything else on card. We will then understand that this is your request to publish your name and address and that you wish to enter into correspondence with other short-wave readers. There is no charge for this service.

—EDITOR.

- JULIO A. AGUAS**
Quito, Ecuador, S. A.
- JAMES F. ARTHUR**
343 E. 195th St., Bronx, N. Y.
- ED ANDERSON**
123 Hollister, Ocean Park, Calif. (Eperanto Student)
- EDWIN H. ARNOLD**
709 Cass St., Niles, Mich.
- H. BEADLE**
13 Chandos St., Keighley, Yorks, England
- FRANK C. BLAUVELT**
532 Pacific, Osawatomie, Kansas
- KENNETH BLOCK**
870 Riverside Drive, New York, N. Y.
- MITCHELL BOYD, WIAXH**
99 Bradford St., Needham, Mass.
- VERNON W. BROWNLEE**
1132 5th Ave., Akron, Ohio
- EUGENE BUTZER**
138 Wash. Ave., Ephrata, Pa.
- P. C. CATALALOS**
Rue Themistocleous 12, Athens, Greece
- R. CLARK**
541 29th Ave., Seattle, Wash.
- JAMES M. CONLEY**
2835a Magnolia Ave., St. Louis, Mo.
- JAMES M. COVINGTON**
Corregidor, Cavite, Philippine Islands
- RALPH E. CRAIG, W9DIX**
R. F. D. No. 4, Box No. 48, Madison, Nebraska
- CARL DANBURY**
Kanawha Falls, West Va.
- JAY B. EASTMAN**
Route 1, Belleville, Michigan
- EDWARD FALLS**
2641 Arrowhead Ave., San Bernardino, Calif.
- R. FAVERHACH**
412 Fulton St., Millville, N. J.
- KARL GAMBICKLER**
3144 Decatur Ave., Bronx, N. Y.
- FRANK GREGOR**
1921 West 14th Ave., Gary, Ind.
- CECIL F. HARDY**
Denison Radio Lab., Denison, Texas
- WALTER R. HARIU, W9HSL**
Route 1, Box 75, Hurley, Wis.
- O. J. HUNTER**
721 1/2 Garvin Ave., Charleston, W. Va.
- EDWIN IDLETT**
5324 Rolston Ave., Norwood, Ohio
- A. C. JORGENSEN, U'SNR, RM2C, W9GKE**
503A West Chambers St., Milwaukee, Wis.
- FRED MANESS, JR., W4AZP**
Route No. 6, Box 109, Monroe, N. C.
- LAURENCE H. MEACHAM, W9HDR**
Richland, Iowa
- OSCAR NELSON**
38 St. Anthony St., Worcester, Mass. U. S. A.
- ELMER NEUMAN**
2224 Woodstock Ave., Swissvale, Pa.
- MARVIN L. NIELSEN, W9FNX**
Edna, Iowa
- PETER PASSERA**
Box 410, 223 Crest St., Clairton, Pa.
- MERLIN E. PAUL**
10206 Wilbur Ave., Cleveland, Ohio
- SWAN PAULSON**
1226 Fletcher St., Chicago, Ill.
- JOHN E. PENN**
R. R. No. 1, Florence, Ky.
- WILLIAM H. PERSHING**
Odon, Indiana
- ARTHUR POLIK**
45 Zelmer St., Buffalo, N. Y.
- W. NELSON RICH**
33 Fourth St., Stamford, Conn.
- JOSEPH J. SARNO, W8AEF-KFBX-W9EMT**
Naval Radio School, San Diego, Calif.
- WALTER SCHWAB**
398 South Ninth St., Newark, N. J.
- BERNARD SIKORSKI**
29 Zelmer St., Buffalo, N. Y.
- ARTHUR SMITH**
1003 N. Popular St., Ottawa, Kansas
- KENNETH SMITH**
North Marshfield, Massachusetts
- JOHN TAFRA**
1011 Geyer Ave., St. Louis, Mo.

New DELFT Sets

IN keeping with a policy of always supplying the latest in short-wave receivers and transmitters, Delft Radio Co. has developed a new and sensitive short-wave two-tube receiver which is available either in "Kit" form or completely assembled. This circuit gives loudspeaker volume. It is interesting to notice the circuit improvements that the new sets employ.

In Fig. 1A, an ordinary two-tube short-wave diagram of connections is shown. Fig. 1B is similar except that resistance coupling is employed, as becomes necessary for television purposes. Fig. 1C shows a two-tube hook-up employing a screen-grid detector and a pentode tube in the audio stage. These very sensitive and inexpensive tubes give results that are really surprising in comparison. It was extremely interesting to notice the development of the latest circuits in the laboratories of the Delft Radio Co. and to notice the superior results obtained.

Besides the latest receiving sets, Delft Radio also manufactures transmitting sets and wavemeters for all purposes. This company specializes in short-wave and ultra-short-wave apparatus. Special short-wave apparatus of all kinds is manufactured, including ultra-short-wave apparatus and prospecting instruments.

The different uses of a wavemeter are very numerous. No short-wave fan can afford to get along without one. Realizing this, a new and very inexpensive wavemeter has been placed on the market. The reader is referred to an article by this writer in the last issue of SHORT WAVE CRAFT for the many uses of one of these meters.

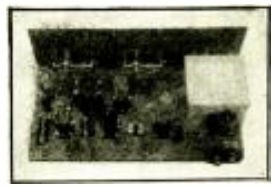

Delft 4-Tube Kit Assembled.

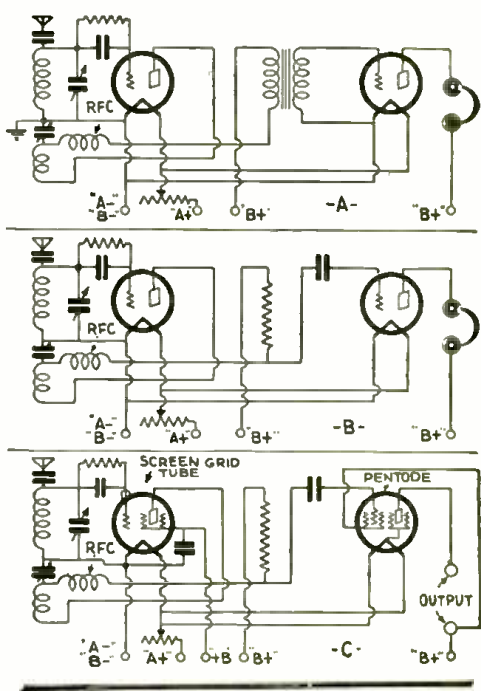

- EDWARD A. TURNER**
P. O. Box 234, Hoboken, N. J.
- GODWIN WILLIAMS, JR. (WIAHD)**
Masonic Home, Decoto, Calif.
- H. C. WANDSCHNEIDER**
Box 73, Lengby, Minn.

How Research and Industry Depend on Vibrations

By DR. WILLIS R. WHITNEY

(Continued from page 342)

hurt except in appearance, and ate out of my hand at once. Now I am not advocating this as a painless surgical process; but will the day ever come when we may be warmed internally in unheated houses by some external radio field? It might be useless to heat our houses with all their contents including the air, if we could get along by internally heating ourselves. Our early ancestors did it without radio. They carried enough heat with them, and their rooms were not heated in their absence. If we carry the body temperature higher than about 98° F., we say we have a fever. We found first with rats that fevers were harmless unless above 106; and rats have withstood 111°. Dogs cannot usually recover after being exhausted by several hours of electrical fever of, say, 107°; but all animals stand indefinitely a few degrees of fever. It is a wonderful way of reducing weight, for the animal peacefully perspires his fat away. (This is not advertising for reducing.)

One day a veterinary brought us a little white Boston bull terrier which he said was going to die of dermidectic mange. It couldn't do any harm for us to experiment on her, and we accepted her as a gift and called her Lydia. Enclosed in her little wooden kennel, she was subjected to an hour's electric fever daily. It is a long story full of human interest; but the dog got well. The human interest was so great that Lydia also got all the medicine we could think of, in addition to the fevers. She was put on a strict diet daytimes, and accompanied the watchman on his rounds at night, so it may have been a faith cure. It was clear, however, that repeated electrical fevers do not hurt small white bulldogs.

Curative Power of Radio

All this in turn led to our finding that human fevers may not be all bad, but some are probably beneficial; and we learned about the work of Dr. Wagner-Jauregg, of Vienna, who had cured cases of advancing paresis by producing at

will fevers of malaria in the patient. There was only one thing to do then. We made a few devices and lent them to institutions where it seemed probable that the indicated studies could be well made.

It is not new to heat the body by external means and to produce fevers thereby. It has been done by hot water baths, but the patients usually have to be tied down before they will submit to it. It is also not new to heat a human being by strapping electrodes to him and applying alternating current of high frequency; but it is new to heat the individual by radiations or electromagnetic energy emanating from an antenna!

For uniformity, the present method is to let the patient lie on a cot with antenna plates above and below, but not touching him. It is at present being studied largely, as a substitute for the purposeful malarial-fever infection, which is the wonderful service Wagner-Jauregg rendered after painstaking studies over many years.

I do not profess to know the action, but the guiding thought was this: In such diseases as paresis there is a blood parasite whose ultimate goal seems to be the brain cells of the host. It gets there effectively only after a long siege in the blood stream and spinal fluid, but the mind is finally affected and, until Wagner-Jauregg's work, I believe that there was no cure. He showed a way, through introducing fevers, to save at least some of the afflicted. It seemed a natural thing to assume that the fevers finally made the parasite give up in disgust, not being able to stand the heat. This general principle must be tried on various human and animal troubles.

There are now several groups of competent American doctors and research men in well-equipped institutions who are making these studies, and it seems from their reports that there is hope for service from this particular radiation number, ten thousand trillion!—From a Talk presented by Dr. Whitney at a meeting of the Chamber of Commerce, Boston, Mass., May 7, 1931.

Hints on A.C. Operation of S-W Receivers

By "BOB" HERTZBERG

(Continued from page 339)

coil L1 and tuning condenser C1. The control grid is biased by the plate current's drop through R1, of 500 ohms. All by-pass condensers C3 are .01-mf. mica units, connected as close as possible to the socket terminals. The screen lead contains an R.F. choke, Ch1, of the ordinary receiving type. The variable resistor R7, which is of the "stepless" compression type, should be adjusted until the voltage on the screen, as measured between screen and ground, reads 75. This control is quite helpful in maintaining the stability of the R.F. amplifier. The writer has examined many A.C. re-

ceivers in which the R.F. amplifier oscillated quite badly, and invariably found that the trouble was due to excessive screen voltage.

Coil L2 is the usual two-winding detector inductance, tuned by condenser C2. L1 and L2 may be any of the standard short-wave plug-in coils on the market. The correct capacities for C1 and C2 are those specified by the coil makers, and usually run to about 150 mmf. or thereabouts.

The plate of V1 is fed through the grid winding of coil L2, the plate voltage be-

(Continued on page 360)

AERO WORLDWIDE SHORTWAVE RECEIVER
\$6.45

Listen In DIRECT to London, Paris, Berlin, Buenos Aires and other broadcast stations throughout the world via short waves. Your ordinary receiver cannot tune in these low wave stations. **WORLD-WIDE RECEIVER** sets 14 to 550 meters.



AERO SHORT WAVE CONVERTERS
 Convert Your Present Set Into a Short Wave Super-Heterodyne.

A. C. MODEL \$12.50—D. C. MODEL \$11.50
At Last! The Perfect Auto Radio. Only \$20.00
 Built by pioneers in the manufacturing of Auto Radio. We guarantee 1,000 miles radius of reception. A masterpiece of Radio engineering. Latest model 6 Tube Aero Pentode Auto Radio. Price of set only \$20.00. Set complete with tubes, batteries, dynamic speaker, antenna equipment and noise suppressors, \$39.50.

NEW AERO MIDGET
 Using the Latest Type Pentode and Multi-Mu Tubes
Price \$16.50

We guarantee **COAST TO COAST** Reception
 Wonderful tone quality and selectivity. Full dynamic speaker. Full vision dial. Beautiful walnut cabinet. 5 Tube Set \$16.50, less tubes. Complete set of 5 matched tubes \$4.50 extra.

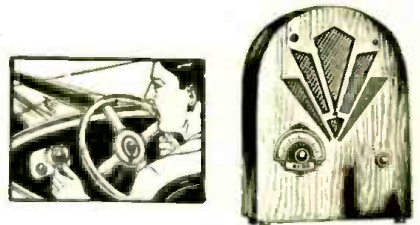

SEND FOR COMPLETE CATALOG

CHAS. HOODWIN COMPANY
 Dept. M-17 4240 Lincoln Ave. Chicago, Illinois

KNOW the EFFICIENCY of your tubes

Tests all tubes in general use—Including the new Pentode and Variable Mu series. Uses only two sockets! By turning selector switch to designation on chart of type of tube to be tested, accurate readings may be made in a minimum of time! Correct readings for each type of tube are permanently indicated on the chart, as your accurate guidance.

Ideal for use by service men, dealers, experimenters and even for the consumer who wishes to test his tubes at home. The price makes it possible for everyone to own.

MADSEN INSTRUMENT COMPANY
 98 Park Place, New York, N. Y.



You Can Become a Fast Capable **RADIO OPERATOR** at HOME

By **CANDLER** Scientific Method

In less than half time required by any other. Nothing like it. Amazing results. **FREE ADVICE** if you're "stuck." Thousands fast Radio operators taught by **CANDLER**, world's only Code Specialist. **FREE BROCHURE** will save you time and money. All questions answered personally. No obligation. If Radio operator, ask about **ADVANCED COURSE** for **SPEED** and **Copying** Certificate, and "MILL" Course.

THE CANDLER SYSTEM CO., Dept. SW-5
 6343 So. Kedzie Ave., Chicago, Ill.



"HAM" ADS

Advertisements in this section are inserted at 4c per word to strictly amateurs or 8c a word (8 words to the line) to manufacturers or dealers for each insertion. Name, initial and address each count as one word. Cash should accompany all "Ham" advertisements. No less than 10 words are accepted. Advertising for the April-May issue should reach us not later than February 10.

\$6.00 WILKENS FIVE-WAVE SW CONVERTER—\$6.00. Makes your present set a short wave screen grid superheterodyne. Fits any set; tunes from 15-150 meters. Housed in attractive aluminum cabinet. Sent complete WITH TUBES, POSTPAID. Wilkens Lab., 241 S. 11th, Reading, Pa.

FOR SALE—Pilot A.C. Super-wasp with tubes, coils, power-pack, signal cabinet and 171 amplifier. Price, \$33.00, Victor Soens, R. No. 7, Iowa City, Iowa.

NOTED QSL CARDS—Your station should be represented by a good QSL card. We give snappy service on printing good quality, two color cards, stationery, and message blanks. Write for free samples today. WIBEF, 16 Stockbridge Ave., Lowell, Mass.

SHORT WAVE LISTENERS' CARDS—Report the stations you hear on your own short wave listeners' card. We print just the type of card you need. Write for free samples today. WIBEF, 16 Stockbridge Ave., Lowell, Mass.

SACRIFICE \$125 AC HY-7 complete \$65. Also parts and trade. Write Warren Conrad, 654 Grant, Wooster, Ohio.

BRAND NEW \$75 De Vry 16 mm. projector complete with cord and lamp to trade for A.C. or D.C. Super Wasp complete or what have you. Fred Braun, Galena, Kansas.

SHORT WAVE BLUEPRINTS—Send 25c (coin) and receive five short wave blueprints consisting of 1, 2, 3 and 4 tube D.C. and one five tube A.C. all wave indget. Build any one of these circuits and receive real D.X. results. S. Jordan, 1313-40th Street, Brooklyn, N. Y.

CRYSTALS—Guaranteed square x cut power crystals. Your approximate frequency, 3500 kc. band, \$3.00. Evert G. Johnson (8DLM), 555 W. 4th St., Rochester, Mich.

WANTED—Good S.W. Receiver cheap for cash. Electric preferred. Write particulars and price. L. J., 143 B'way, Brooklyn, N. Y.

1931 I. C. S. complete radio course, 28 lessons. Excellent condition. Sell \$20 or swap. What have you? Walters, Box 31, Skykomish, Wash.

TWENTY-FIVE DOLLARS one tube. Sun short wave receiver. Pilot Parts, Octo coils. Amplifier with Thordorson transformers, tubes and Baldwin phones.

Navy aeroplane receiver, three thousand meters. Crystal or tube operation. Twelve dollars. Detector and two step amplifier with Stromberg transformers. Five dollars. New French Rifle Range Telescope. 33 Power. Five sections. Leather case. Twenty dollars. Frank B. Mecker, 60 John Street, New York City, care of Globe.

EXTRA SPECIAL—Type 866 Mercury Vapor Rectifiers, new, first grade tubes (not seconds), guaranteed 1000 hours, only \$2.85; Type 211B 75 watters, \$8.00; Heavy duty 210, \$1.50. Include postage with order. Hudson Amateur Service, Plermonth, New York.

Get Started in RADIO

Write for free booklet telling about this growing and most promising industry. The radio operator is an officer aboard ship. His work is light, pleasant and interesting. He has many opportunities to travel to all parts of the world. You can qualify in a short time in our well-equipped school under expert instructors.

A new course in TELEVISION starting soon
Full information on request
Educational Department

WEST Y.M.C.A. 7 West 63rd St.
SIDE Y.M.C.A. New York

ing kept off the grid of V2 by the grid condenser C4, of 0.0001-mf. Condenser C3, of 0.01-mf., prevents the high voltage from shorting itself to "B". R6 is the usual grid leak of two or three megohms. V2 is another '35 tube, which is particularly well suited for use as a regenerative detector, being better than a '24 for this purpose. The regeneration control is a 100,000-ohm potentiometer, R8. The regenerative action will be affected by the value of the by-pass condenser C5, which should be about .00025-mf. This condenser may well be one of the small screw-type adjustable condensers, formerly used for neutralizing and balancing purposes. Its capacity should be varied until the smoothest regenerative action is obtained.

Ch1 is another R.F. choke, while AC is an audio choke of about 750 henries. If a special choke of this size cannot be obtained, try the secondary winding (alone) of a good audio transformer, or the primary and secondary together connected in series.

C6 is a 0.01-mf. grid blocking condenser, and should be a good mica condenser. R5 is a grid leak of about 250,000 ohms.

The first audio amplifier tube, V3, is a '27. Its grid is biased by the 2,000-ohm resistor R2, which is by-passed by C7, of 0.5-mf. T1 may be any good audio transformer. The phone jack is connected in the plate circuit of V3, as this is the best place for it. Condenser C8, of 0.5-mf. capacity, allows the audio component of the plate current to pass to the phones, and at the same time keeps the direct plate current out of them.

The last audio tube, V4, may be either a '71A, a '45, or a '47. For a '71A, R4 should be 50 ohms and R3 is 2,250 ohms. For a '45, R4 is 20 ohms and R3 is 1,500 ohms. For a '47, R4 is 20 ohms and R3 is 400 ohms. The plate voltage to be applied to post "PB+" is 220 for a '71A, 300 for a '45 and 265 for a '47. For each particular tube a suitable output transformer T2 must be employed; special transformers for the '47 pentode are now

available. The loud speaker may be of any good dynamic type.

Getting Rid of "Hum"

Many short-wave fans who do their listening mainly with phones have found that, in spite of everything they do to their A.C. power packs, they are not able to obtain that "velvety-smooth" control of regeneration and complete freedom from hum and background noise so essential to really perfect S.W. reception. The fault is sometimes in the power line, and sometimes due to the poor regulation-characteristic of the power pack. The thing to do then is to make a combination A.C. battery outfit, using A.C. on the filaments of the regular A.C. tubes, and "B" batteries for plate supply. This sounds like a funny arrangement, but it really is a very good one from all standpoints and is highly recommended.

A small filament-lighting transformer costs very little; while a set of three or four medium size "B" batteries costs only a fraction of the price of a special short-wave power pack, and will last at least a year under ordinary conditions. The drain of three tubes, for phone reception, is very light, and the batteries will give long and trouble-free service. For loud-speaker reproduction, the output of the set can be fed to a separate single-tube power amplifier of all-A.C. design.

The hook-up of Fig. 2 can be followed exactly, up to and including V3, for such a combination set. The only additional instrument is a switch to break the "B—" lead; this is needed to open the otherwise continuous circuit formed by potentiometer R8. There is available a standard double-pole, single-throw switch that is ideal for this work. One pole is used to control the 110-volt primary circuit of the filament transformer, and the other to open the "B" circuit.

Of course, the phones should be connected directly in the plate circuit of V3. If a double closed-circuit jack is used, the two inner springs can be connected to the primary of the audio transformer in the separate power amplifier, if one is employed.

Single Sideband Transmission on Short Waves

By C. H. W. NASON

(Continued from page 338)

In the complete receiver used in the tests, the "pilot" wave is 3.47 kc., removed from the carrier frequency (which is, of course, not present at the receiver input). Reception of this signal on an ordinary receiver will give "inverted" speech—displaced about 400 cycles from normal inversion. It may be received, however, with an oscillating detector tuned to the frequency of the suppressed carrier.

It will be noted that the frequencies shown in the various units of the complete receiver differ slightly from those given in Fig. 1. This is because of the fact that certain apparatus was immediately available for the commercial tests, and not because these frequencies were the best for the purpose. The time constant circuits "A" are those previously described as affecting the gain of the first I.F. stages, in order to hold the amplitude of the "pilot" constant. In the actual receiver, a three-section time-constant circuit was found to give the smoothest action. After passing through the second detector, the speech frequen-

cies lie wholly within the range from 20 to 23 kc. The 20-kc. oscillator shown in the figure serves to resupply the original carrier prior to detection by means of a Carson "balanced demodulator".

Undesired components in the low-frequency output of the "demodulator" pass through a low-pass filter, cutting off sharply at 3,000 cycles; and through a repeater or amplifier out into the commercial telephone lines.

The transmitter for single-sideband signals does not differ greatly from the normal type, outside of the fact that a balanced modulator and a filter system (suppressing respectively the carrier and the lower sideband) are necessary. A separate oscillation, having a frequency removed 3.47 kc. from the carrier, is introduced into the R.F. amplifier circuits, subsequent to the circuits providing the desired modulation and suppression. The tuned circuits are broadly enough tuned to accept this signal, which is of so low a level as not to tax the capacity of the amplifiers.

Technical information from the July, 1931, issue *Electrical Communication*.

Antennas for Ultra-Short-Wave Transmitters

By HARRY D. HOOTON, W8BKA

(Continued from page 338)

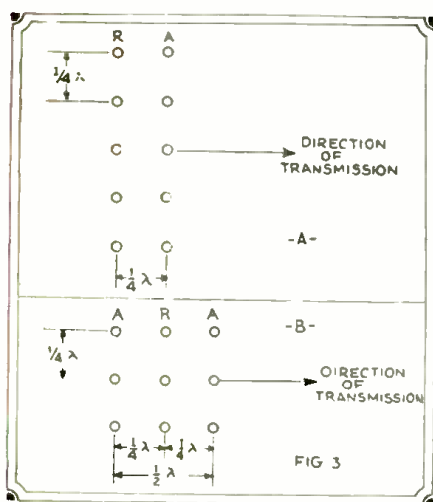

Fig. 3—Shows direction of transmission for ultra short wave antennas and position of reflectors at R.

set the wires at one-fourth wavelength distance from the main antenna. Several different spacings between the reflector wires may be used with apparently equal efficiency. In the three-wire system mentioned above, the reflectors were placed at one-fourth wavelength from the radiator and from each other. However, when using several wires in an elaborate directive system, some other wavelength spacing is more desirable in order to get a number of reflectors around the radiator.

When operating on the $\frac{3}{4}$ -meter band, the whole antenna reflector system may be mounted on a "breadboard", making it

easily movable for transmission in any desired direction. Antennas for this band are usually constructed of $\frac{3}{8}$ -inch copper tubing and each reflector is mounted on a stand-off insulator. A one-half wave radiator for this band will be approximately 1.1 feet or 1 foot, 1 $\frac{1}{2}$ inches. When designing the antenna for this band, allowance must be made for the mounting screw in the insulators; since an amount of variation as small as one-fourth inch will often throw the reflector off balance at such extremely high frequencies.

The chief difficulty experienced with an antenna of the type shown in Fig. 3 at *a* is in getting a suitable feeder system. Practically the only method is to run a pair of feeder lines to each radiator. Each radiator is cut at the center, and the feeder lines are inserted for current feed.

The efficiency of the simple two wire antenna system (Fig. 2A) can be increased by placing an additional reflector one-fourth wavelength behind the first reflector, or one-half wavelength behind the main antenna.

The experimenter can design directive antennas for himself, if he will bear in mind the fundamental principles of directive transmission. The idea is to set one or more resonant wires at a certain wavelength distance (spacing) where they absorb power from the radiator. When this spacing is correct, the resonant wire re-radiates power and reinforces the radiated wave, in a direction through both wires and from the reflector wire through the radiator or main antenna.

A New "Bug" Key for the Amateur

(Continued from page 328)

of its duty, it does not hold the romance and glamor of an electrically operated device.

It is necessary, in most cases of high-voltage keying, to employ a relay in order to keep the dangerous high potential away from the operator's hands and to prevent arcing. Inasmuch as we are to employ a relay anyway, a little additional equipment will not complicate the situation and, by using a single vacuum tube with a tuned A.F. transformer, we can make one of the finest automatic keys that ever graced the operating table.

In the schematic circuit shown the key (K) is a regular lateral key with the three contacts insulated one from the other. Contact to the left allows the plate voltage of the tube to be applied through the relay without passing through the tuned circuit (CL) so that the relay will stay closed as long as the key is held over. Contact to the right, however, passes the plate voltage through the tuned circuit, and the tube then oscillates at a frequency determined by the circuit constants. The relay will open

and close at a rate of one-half the frequency of oscillation, making a series of sharply-defined dots. The frequency of oscillation should be adjusted so that the number of dots per second coincides with the speed at which the station's operator usually transmits.

Relays for this purpose are made by Leach, Bunnell, Ward Leonard and others or they can be readily made up from an old high-resistance telegraph sounder. The oscillator windings are supplied by any A.F. transformer of normal characteristics. While the primary and secondary inductance values of transformers vary in so large a degree that it is difficult to specify the capacity values of C and C', they will lie somewhere between 0.1 and 2 mf. The condenser across L', which should be the secondary of the transformer, will be slightly smaller than the other condenser. An '01A, '27 or similar tube serves as the oscillator, and the required plate and filament voltages can be tapped off from the receiver without in any way harming its performance.—C. H. W. Nason.



Won't I Ever Get Ahead in Radio?

Progress in radio is determined purely by *Final* educ. Even practical experience doesn't help if you haven't got a *FULL KNOWLEDGE OF RADIO FUNDAMENTALS*.

There's more to radio than just knowing *HOW* to repair or construct apparatus—you've got to know *WHY* it operates after you do! To men who are striving toward a *REAL FUTURE* in Radio—whether as Service Men, Factory Engineers, Transmission Men, Operators or Broadcast Engineers—we offer an endorsed course of training that, by teaching *BASIC RADIO ENGINEERING*, makes you fit to hold these important jobs.

GET THE DETAILS

The coupon brings you interesting booklet and full particulars by return mail. No obligation. Mail it now—while you think of it.

CAPITOL RADIO ENGINEERING INSTITUTE, INC.

14th St. and Park Rd., N. W., Dept. B-13, Washington, D. C.

Without obligation, please send me details about your home study training in Radio or Television.

Name

Address

Town..... State.....

Universal Microphones
Proved Value—Superior Performance
 Unparalleled values at rock-bottom prices. Enthusiastically endorsed for every sound use. Exclusive design features—superior workmanship. Tested performance. **BABY MIKE** List Price \$7.50
 Complete line of microphones, stands, cables, etc. . . . at challenging prices. Unconditionally guaranteed. Consider carefully the **UNIVERSAL** line before you buy. For sale by dealers everywhere.
2-Button Hand-Mike, List Price \$15
 Universal Microphone Co., Ltd. 1163 Hyde Park Blvd. Inglewood, Cal., U.S.A.

Send for FREE



THE AIREX CO, Inc.
 67 Cortlandt St., New York City

What Are You Doing to Prepare Yourself for the Future?

Have you definitely decided upon your career or are you still groping in the dark?

Why Not Go Into a Growing Field Where There Are Unlimited Opportunities for Advancement?

Radio and its numerous branches are virgin fields and the men in the industry have splendid opportunities of getting ahead.

Have a Training That You Can Fall Back Upon and Insure Your Future!

Don't be caught in an economic upheaval. Be prepared with another vocation—you have two chances of getting a position.

We Teach You Everything You Need to Know to Qualify Yourself as an Expert.

Our system has made specialists of men of ordinary school education.

The Price of This Training is a Small Percentage of What It Would Cost Otherwise to Obtain.

After you read our pamphlet SW-7 you will learn that our system will cost you only one-third of what you expected to pay.



Teleplex Company
76 Cortlandt Street, New York, N. Y. SW-7

I am very much interested in laying the foundation for a better future and would like you to send me your pamphlet which explains all. I am not obligated in any way.

Name

Address

City..... State.....

WHEN TO LISTEN IN By "BOB" HERTZBERG

WE are glad to report that an unusually large number of letters have been received this past month from many hitherto inaccessible foreign short-wave stations. We will quote directly.

Barranquilla, Colombia

"With great pleasure I will give you the information you ask for, regarding my short-wave broadcasting station HKD.

"The call letters are HKD, our slogan 'The Voice of Barranquilla,' the location is Barranquilla, Republic of Colombia. The wavelength used is 50 meters, or 6,000 kilocycles. We are on the air on Monday, Wednesday and Friday between 8:00 and 10:30 p.m., and on Sunday between 7:45 and 8:30 p.m., Eastern Standard Time. On week days we broadcast a concert played by orchestra from 8:00 to 9:00 p.m. At 9:30 p.m. we have a short talk and give the latest news, and from 9:00 to 10:30 p.m. a variety program played at our studio by different orchestra or vaudeville artists. On Sunday we broadcast the open-air concert played by the State's Police Band at Bolivar Square.

"We are very severe in sending verification cards. At least two selection names and the time they were played are necessary to receive a card."

—ELIAS J. PELLET,
Owner and Engineer, HKD,
P. O. Box 715,
Barranquilla, Colombia.

Vatican City

The following schedule of HVJ is taken from a letter from the Vatican City:

Radio Station HVJ—Citta del Vaticano
Every day: 10:00 to 10:15 G.M.T. on 19.84 meters (5:00 to 5:15 a.m., E.S.T.)

19:00 to 19:15 G.M.T. on 50.26 meters (2:00 to 2:15 p.m., E.S.T.)

Notices from Vatican and from Missions.
Sunday: 10:00 to 10:30 G.M.T. on 50.26 meters (5:00 to 5:30 a.m., E.S.T.)
Lithurgic and spiritual lectures.

Sonning-on-Thames, England

"I beg to inform you that my station is still carrying out the regular schedules on 20.95 meters on Sundays at 18:30 G.M.T. (1:30 p.m., E.S.T.). If any listeners would like to suggest any additional tests I shall always be pleased to try out any other times at request."

—GERALD MARCUSE,
Station G2NM,
"The Ranch," West Drive,
Sonning-on-Thames, England.

Konigs-Wusterhausen, Germany

A letter from the Reichs-Rundfunk-Gesellschaft, Berlin, Germany, states that the short-wave station at Konigs-Wusterhausen works on 31.38 meters between 8:00 a.m. and 7:30 p.m., E.S.T., with a power of five kilowatts. It relays programs from various German broadcasting stations.

Venezuela

H. H. Garton, 5133 Webster Street, West Philadelphia, Pa., and Martin Melland, 428 14th Street North, Virginia, Minn., both report station YVQ, in Venezuela, South America. The wavelength is 16.39 meters or 18,300 kilocycles. It tests with WLO and WOO (American radio-telephone stations) during the morning hours. Volume and clarity both good. This station also transmits telegraph signals, which are so strong in New York that they block the detector tube.

U. S. S. R.

Four short-wave stations are included in an official list of Russian radio stations published in the European press. They are Khavarorsk (Siberia), call RV15, on 70.2 meters or 4,273 kilocycles; Moscow, RV38, on 54.4 meters or 5,515 kilocycles; Moscow-Stehelkovo, RV59, on 50 meters or 6,000 kilocycles; and Minsk, RV62, on 46.72 meters or 6,420 kilocycles.

The Khavarorsk station is well known to listeners along the Pacific coast. The others are new, or rather this is the first real information we've had on them.

Chelmsford, England

"Our experimental short-wave transmitter G5SW transmits as follows: Daily from Monday to Friday inclusive; from 12:30 to 13:30 and from 18:45 to midnight, Greenwich Mean Time or British Summer Time, as the case may be."

—THE BRITISH BROADCASTING CORPORATION,
L. W. Hayes, for Chief Engineer,
Savoy Hill, London, W.C.2,
England.

Above times correspond to 7:30 to 8:30 a.m., and 1:45 to 7:00 p.m., Eastern Standard Time. Station G5SW is located at Chelmsford, England.

Bowmanville, Ontario, Canada

"VE9GW now operates on 11,810 kilocycles, having a power output of approximately 30 watts. Our present operating schedule is from 1:00 p.m. till 10:00 p.m., E.S.T. Our programs originate at the CKGW studios, with an occasional N.B.C. program. Every Saturday evening at 7:00 to 8:00 p.m. this station broadcasts a program dedicated to International Short Wave Club Members. VE9GW will also operate on our old frequency of 6,095 kilocycles some time in the future and will have a power output of 200 watts. When this station goes on the air the schedule will be changed to get the best coverage out of the two channels with respect to the time of the day they operate.

"Reports from great distances will be solicited and each report will be acknowledged."

—W. A. SHANE,
Chief Engineer,
Experimental Station VE9GW,
Bowmanville, Ontario,
Canada.

Hawaiian Islands

The opening of the trans-Pacific radio telephone circuit between California and Hawaii during November was heard by quite a few listeners in the East, who reported station KHK particularly. We have no official "dope" on this station, but several people reported it as located in Hawaii and operating on 7,520 kilocycles.

Japan

Station J1AA, Japan, is reported irregularly on 22.93 meters, 19.93 meters and 38.07 meters, working telephony to the United States.

Short Wave Stations of the World

(Continued from page 345)

- Thur., Sat. 142.9 to 150 meters—2,000 to 2,100 kc. Television (Con.)
- W3AO, Chicago, Ill.
- W3AA, Chicago, Ill.
- 149.9-174.8—2,000-1,715—Amateur Telephony and Television.
- 175 1,715—W9XAN, Elgin, Ill.
- W6KK, Los Angeles, Calif. And other experimental stations.
- 175.2 1,712—Municipal, Police and Fire. —WKDT, Detroit, Mich. —WEY, Boston, Mass.
- WPDB, WPDC, WPDD, Chicago, Ill. —WKDU, Cincinnati, O.
- KSW, Berkeley, Calif. —WKDU, Cincinnati, Ohio.
- KUP, Dallas, Texas. —WMDZ, Indianapolis, Ind.
- KGPC, St. Louis, Mo. —KGOY, San Antonio, Texas.
- KGJX—Pasadena, Calif. (Police Dept.).
- 180.0 1,662—WMP, Framingham, Mass. (State Police).
- RDS, Lansing, Mich. (State Police).
- 186.6 1,608—W3AL, Chicago, Ill. (WMAC) and Aircraft Television.
- W2XY, Newark, N. J.
- 187.0 1,604—W2XCU, Wired Radio, Ampere, N. J.
- W2XCD, DeForest Radio Co., Passaic, N. J. 8-10 p.m., synchronized with television broadcasts.
- W1XAU, Boston, Mass.
- W3J, Wheaton, Md.
- W5XX, Cartersville, Mo.
- W5KN, Dallas, Texas.
- 187.9 1,596—WCF, New York, N. Y. (Fire Dept.)
- WKDT, Detroit, Mich. (Fire Dept.)
- K6KM, Beaumont, Texas.
- K6PA, Seattle, Wash., Fire & Police Depts.

FEBRUARY SPECIALS!!

WE are announcing an important new departure this month. Every month we will show on this page certain **STAR** items, which are **NOT LISTED IN OUR CATALOG**. These are all specials of which the quantities on hand are not sufficient to catalog them. *Once sold out, no more can be had.*

STOP SHOPPING. The lowest prices are right on this page. *No one undersells us.* We meet any price on ANY NEW Merchandise. Order direct from this page and save money. 100% satisfaction on every transaction. Take advantage of these special offers. **ORDER NOW, TODAY.**

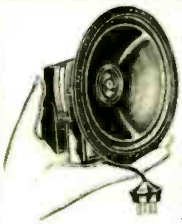

NEW! "LITTLE GIANT" DYNAMIC SPEAKER

Absolutely the smallest dynamic speaker that will withstand the strain of modern output power tubes ever manufactured. Suitable for use on midset, portable and automobile receivers. Measures but 6 1/4 in. long over-all, having a 1/2 in. diaphragm and weighing but 4 lbs. The "Little Giant" has, under test, actually flooded a ten-room apartment with faithfully reproduced music of virtually original tone quality. Field winding has a resistance of 2500 ohms and may therefore be energized by using it as a filter choke in the power pack, thereby serving a double purpose. This last feature makes the "Little Giant" an excellent suited for portable A.C. sets, since it does away with filter chokes and thus with considerable weight. Equipped with built-in output transformer to work from any standard output power tube arrangement. Specify the power tube or tubes used when ordering. Shipping weight 5 lbs. List Price, \$9.50. No. 1549. LITTLE GIANT DY. N.A.M.C. SPEAKER. Your Price. **\$2.50**

*SERVICEMEN'S SPECIAL TEST PRODS



Here's what every serviceman and field experimenter has been waiting for—test leads that **CAN PIERCE THE Toughest OF WIRE INSULATION AND TAKE VOLTAGE AND OTHER MEASUREMENTS WITHOUT THE NECESSITY OF STRIPPING WIRES.** These test prods are so constructed that instead of the usual phone tips, adjustable chucks, capable of securely gripping steel phonograph needles, are permanently attached to the ends of the insulated handles. The use of these prods completely eliminates the introduction of errors in meter readings caused by poor-contact resistance or resistance resulting from the presence of dirt and grit. Five feet of flexible, color-coded leads securely soldered to the metal chuck insure permanent and positive electrical contact. The other ends of the test leads are provided with convenient U-shaped connection lugs. Shipping weight—1/2 lb. List Price, \$1.40. No. SP9055—Servicemen's Special Test Prods. Your Price. **\$.35**

*FLECHTHEIM PORTABLE VOLT METERS



Flechteim's superior built instruments have well earned a reputation of reliability for their unusual life and accuracy in actual use. These voltmeters which are available in two types, namely, 0 to 500 volts DC and 0-500 volts AC-10", and which have an internal resistance of 60 ohms per volt are sturdily and attractively constructed in a nickel-plated, highly-polished protective shield case. The scales are evenly and accurately calibrated so that although the range is higher than 500 volts, the comparatively low voltage of 5 can be easily and quite accurately recorded. Each meter is of the portable type, being provided with convenient mounting rings for banking on walls or test panels. Sold complete with 3 ft. flexible test leads provided with phosphor bronze, non-corroding test tips and non-breakable color-coded insulated handles. Shipping weight—1/2 lb. List Price, \$7.50. No. SP9051—0-500 DC Voltmeter. No. SP9052—0-500 AC-DC Voltmeter—Your Price. **\$3.25**

*WEBSTER "250" POWER AUDITORIUM AMPLIFIER

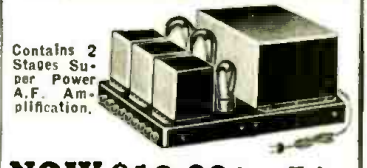

Contains 2 Stages Super Power A.F. Amplification. **NOW \$18.00 Less Tubes** ONE OF THE MOST POWERFUL SUPER POWER AMPLIFIERS EVER MADE. Ideas for theatres seating approximately 3,000 people, dance halls, schools, lectures, hospitals, auditoriums, outdoor gatherings, etc., etc. The gigantic power is at all times within control—for that matter it can be used in any home, as the volume can be regulated down to a whisper! But most important of all, the **QUALITY OF REPRODUCTION IS AS NEAR PERFECT AND LIFE-LIKE AS POSSIBLE! ITS POSSIBILITIES CAN BE SUMMED UP IN THREE WORDS: ABSOLUTELY DISTORTIONLESS VOLUME!** The full benefit of the 450 volts produced is obtained. This famous amplifier is provided with a high quality input transformer for working from a phonograph pick-up or single or double button microphone. The tubes required are 1 '26, 1 '50 and 1 '81 rectifier. Where the maximum output is not required a '10 may be substituted for the '50 in the output. Automatic adjustment takes care of the discrepancy in voltages. The undistorted power output is 2.5 watts—ENOUGH FOR FOUR DYNAMIC REPRODUCERS. This degree of power output provides satisfactory coverage for auditoriums having volume of 25,000 cubic feet when used with a dynamic speaker having a flat baffle board, 50,000 cubic feet when used with a speaker having a directional baffle or horn. Over-all dimensions are 15" long by 10" wide by 6 1/2" deep. Shipping weight—34 lbs. List Price, \$45.00. No. SP9053—Webster "250" Power Amplifier. Your Price. **\$18.00**

*RCA VICTOR 11-INCH DYNAMIC SPEAKER

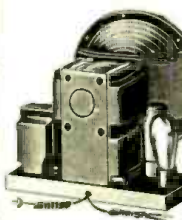

For 110-20 Volts 60 Cycle Operation. A superior, heavy duty unit embodying all the fine principles of construction and operation typical of all RCA and Victor radio equipment. Designed especially to accommodate large theatres, ballrooms and outdoor stadiums. Includes a completely shielded, heavy duty power transformer feeding a type 2B0 full wave rectifier which energizes the field coil with smooth, unflinching current. In addition this current is thoroughly filtered by an 8 mfd. electrolytic condenser which completely reduces hum to an absolute minimum. A special high quality output transformer, to operate out of any standard arrangement of power tubes, is furnished with each unit (specify the type of power tube or tubes employed when ordering). Both speaker and electric cords and plugs are supplied with speaker as is the '50 rectifying tube. This over-all dimensions are 12" high, 12" wide and 8" deep. Provided with adequate mounting facilities. A 9" corrugated cone insures strength and durability under the most powerful operating conditions. Capable of handling a tremendous amount of volume without distortion. Designed for 110-20 volts 50-60 cycles. Shipping weight—32 lbs. List Price, \$25.00. No. SP9056—RCA Victor Dynamic Speaker. Your Price. **\$13.50**

FREE 76 Page Radio Treatise No. 24



The new Winter edition of our RADIO SERVICE TREATISE, twice as large as our former one, has just come off the press. It is positively the greatest book in print—NOT JUST A CATALOG. It contains a large editorial section—a veritable book in itself—with valuable information NOT FOUND ANYWHERE ELSE. Among the wealth of new technical information listed in the editorial sections are the following: 1932 Complete Radio Characteristics SHORT-WAVE TUNERS and PHONO-PICKUPS.—CONSTRUCTIONAL LIST OF SERVICEMEN'S TEST OSCILLATOR—ALL ABOUT TONE CONTROLS—SHORT-WAVE ADAPTERS AND CONVERTERS—CONSTRUCTING A 3-TUBE SUPER-HET SHORT-WAVE CONVERTER.—MODERN OLD RADIO SETS.—LATEST TYPE MULTI-MU AND PENODE TUBES.—ALL ABOUT DC RECEIVERS.—VACUUM TUBES TREATISE.—And dozens of new radio experiments, hints to Servicemen, valuable tables of useful data, etc., etc. This book is not just another catalog but a veritable mint of radio information which will be of infinite and everlasting value to you. WRITE TODAY. Enclose 2 cents for postage. Treatise sent by return mail.

100 New Hook-Ups, etc. 675 Illustrations.

6 MONTHS GUARANTEED NEONTRON TUBES

Sold on a 6 MONTHS FREE REPLACEMENT GUARANTEE BASIS. PROVIDING TUBE LIGHTS! All tubes are carefully meter-tested before shipment, and carefully packed. Do not confuse these HIGH QUALITY tubes with any other "low priced" tubes—our low prices are possible because we do a VOLUME business!

Choice	Choice	Choice	Choice	Choice	Choice
225	112A	245	222	230	235
171A	199X	280	210	231	217
171A	199UV-120	171	250	232	234-47
201A	221		281		251
60c ea.	69c ea.	70c ea.	1.38 ea.	1.08 ea.	1.08 ea.

R.C.A. LICENSED TRIAD AND PERRYMAN TUBES

These nationally advertised tubes are guaranteed UNCONDITIONALLY for six months. The prices are slightly higher than our NEONTRONS because these tubes are of much better quality. See listing above for tube numbers.

Choice Price	Choice Price	Choice Price	Choice Price	Choice Price	Choice Price
63c	80c	75c	\$1.76	\$1.15	\$1.15

*MICROPHONE PRE-AMPLIFIER

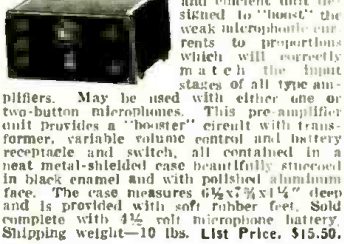

No. SP9057—Microphone Pre-Amplifier. Your Price. **\$7.50**

*6-VOLT BATTERY PHONO-MOTOR

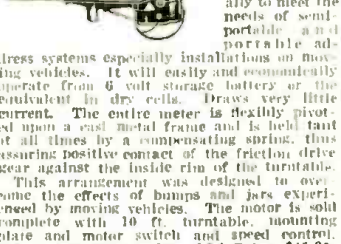

No. SP9058—6 Volt Battery Phonomotor. Your Price. **\$2.50**

*JEFFERSON POWERPACK—CHOK UNIT

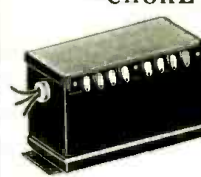

For '26, '27, '71A and '80 Tubes. This unit consists of a standard Jefferson Power transformer and a 30 henry 500 ohm filter choke. Both are mounted in a sturdy, compact, metal case.

equipped with convenient terminal strips and mounting flanges. **JUST THE THING TO CONVERT OLD TYPE BATTERY SETS INTO MODERN ALL-ELECTRIC AC RECEIVERS.** The power transformer will safely handle 5-226's, 2-227's, 2-171A's and standard design and has sufficient DC resistance to cut down the high voltage to the resistive 180 volts for the plates of the 171A power tubes. The only additional parts necessary to construct a complete power pack for AC receivers, power amplifiers or public address systems are a filter condenser bank and a voltage divider. These latter units can be furnished upon request. Complete instruction for hooking up and wiring is supplied with each unit. Shipping weight 10 lbs. List Price, \$10.00. No. SP9053—Jefferson Power Pack \$2.75 Choke Unit. Your Price. **\$2.75**

*Guaranteed 8-Mfd. Electrolytic Condensers

Judiciously used in many parts of any R.F. or A.F. circuits, in power packs, in dynamic speakers, they will perform miracles in eliminating any trace of objectionable A.C. hum or other incidental disturbances. These electrolytic condensers are particularly recommended for 250 power packs. Where the working voltage of the unfiltered A.C. is 800 volts, two electrolytic condensers in series will stand up indefinitely. Easily mounted through the use of a bayonet socket base which is equipped with a "positive contact" spring. Totally shielded and protected by a copper cap. Shipping weight—1 lb. List Price, \$2.50. No. SP9054—Guaranteed 8 Mfd. Electrolytic Condenser. Your Price. **\$4.99**

ARE A WHOLESALE HOUSE AND CAN ACCEPT ORDERS FOR LESS THAN \$3.00. O. D. shipment is desired, please remit 20% advance, which must accompany all orders. All cash accompanies order, deduct 2% discount, money order—certified check—U. S. stamps.

Radio Trading Co.
25A West Broadway
New York, N. Y.

ORDER FROM THIS PAGE. You will find special prices from time to time in this magazine. Get our big FREE catalog for the greatest Radio Bargains. Should you wish goods shipped by parcel post, be sure to include sufficient extra remittance for same. Any excess will be refunded.

12500 Miles on 2 Tubes

Complete kit for the new improved
DOERLE RECEIVER

LIST OF PARTS:

2—UX sockets 10c each.....	\$0.20	Filament switch	\$0.15
1—20 ohm rheostat.....	.20	Panel, 7x12x $\frac{1}{8}$50
1—5 to 1 transformer.....	.75	Baseboard, 7x1220
1—.00014 condenser75		
1—.00025 condenser50		\$4.10
1—.00001 grid condenser.....	.15	Coils wound70
1—5 meg. grid leak.....	.15	2 dials30
1—R F C.....	.15		
Small antenna condenser.....	.20		\$5.10
Binding post strip.....	.20		

YOUR PRICE \$4.50

PARTS MAY BE PURCHASED SEPARATELY
LARGE BLUE PRINT FREE WITH EACH KIT

SWITCHES DO THE TRICK

COMPLETE KIT FOR THIS REMARKABLE RECEIVER
COVERING ALL WAVES WITHOUT PLUG-IN COILS

SPECIAL PRICE ONLY \$7.50

A SIMPLE AND INEXPENSIVE AMATEUR BAND RECEIVER

1—Special tapped coil.....	\$0.75	1—2 meg. grid leak.....	\$0.15
1—23 plate midget.....	.65	Baseboard, 9x14x $\frac{3}{8}$25
1—5 plate midget.....	.55	3—L shaped mountings.....	.35
1—A. F. Transformer.....	.75	Antenna condenser20
2—1A Ballasts50	2—Ballast mounts35
2—UX Sockets20	Miscellaneous parts25
Hook-up wire10	Fahnestock clips10
1—Clarostat30		
1—1 mfd. condenser.....	.30	Total	\$5.90
1—.002 condenser15		

PARTS MAY BE BOUGHT SEPARATELY

Complete Kit—Your Price \$5.50

- Navy Transmitting tubes, 5 watts, made by G. E., 550 volts plate, 7.5 filament. All new and in original boxes. Excellent for Short Wave work under 5 meters..... \$0.39
- Air King Short Wave Coils, set of four..... 1.75
- .0001 Midget Condenser for above..... .60
- Latest amateur call Books..... .82

WE SPECIALIZE IN OBTAINING COMPLETE KITS FOR TRANSMITTERS AND RECEIVERS AS DESCRIBED IN "SHORT WAVE CRAFT." ALL MERCHANDISE GUARANTEED.

TERMS: Cash or C.O.D. no deposit required.
All prices F.O.B. Irvington, N. J.

Visit Our Store When in Town

UNITED RADIOBUILDERS
1234-36 • • • SPRINGFIELD AVE.
• • • IRVINGTON NEW JERSEY • • •

The All-Wave Super-Booster

By H. G. CISIN, M.E.

(Continued from page 329)

In addition to its uses as a means of improving receiver performance, increasing selectivity and volume and also adapting the set to short-wave reception, the All-Wave Super-Booster may be used for remote control experiments; since, once it is hooked up, all tuning is done by means of the "Midway" condenser (4).

COMPLETE LIST OF PARTS

- 2—.000365 mf. Cardwell "Midway" variable condensers with mounting brackets (4, 19);
 - 1—Cardwell Rotor Locking Device for Condenser (19);
 - 1—.00035 mf. Cardwell "Balancer" Regeneration Control Condenser, type 609-A (8);
 - 1—Electrad "Truvolt" Adjustable Resistor, type T-20 (17);
 - 1—.0001-mf. Aerovox fixed mica condenser (22);
 - 1—.0002-mf. Aerovox fixed mica condenser (6);
 - 1—.95-mf. Aerovox fixed by-pass condenser (14);
 - 1—0.1-mf. Aerovox fixed by-pass condenser (Optional "X");
 - 2—0.5-mf. Aerovox fixed by-pass condensers, type 207 (11, 20);
 - 1—Eind. All Plug-in type Three-circuit Tuner with fixed tickler (3);
 - 1—Eind. All R.F. Impedance Coil (18); (70 T. No. 28 En. Wire on 1 $\frac{1}{2}$ " dia. tube.)
 - 1—50,000-ohm Durham Metallized Resistor, type M.F.4 (13);
 - 1—500,000-ohm Durham Metallized Resistor, type M.F.4 (15);
 - 1—2 to 10 meg. Durham Metallized Resistor Grid Leak (5);
 - 2—R.F. Chokes, resonating at about 600 meters (9, 21);
 - 1—Trustest Audio Transformer, any ratio (10);
 - 2—Amperites, No. 227 with Mountings (12, 16A);
 - 1—Roll Corvleo Braiddite hook-up wire, solid core;
 - 3—Fire-prong. UY. sockets (3, 7, 16);
 - 2—127 Arceturus Tubes (7, 16);
 - 7—Binding Posts (1, 2, 23, 24, 25, 26, 27);
 - 1—Trustest Vernier Dial;
 - 1—Wood Base, 8"x11 $\frac{1}{2}$ "x $\frac{1}{2}$ ";
 - 1—Composition Panel, 7"x12"x $\frac{3}{16}$ ".
- (NOTE: Numbers in parentheses refer to same numbers marking parts on diagrams.)

A Simple and Inexpensive "Amateur Band" Receiver

By O. G. NELSON

(Continued from page 333)

The following is a list of the accessories necessary to complete the set:

- 2—UX-201A or UX-199 tubes;
- 1—6-volt storage battery (or 3 No. 6 dry cells for UX-199 tubes; 6-volt storage battery or "A" eliminator, such as the Knapp, where the new 6.3-volt automobile tubes are to be used);
- 2—45-volt "B" batteries;
- Aerial and ground.

The aerial and ground systems need not differ from those used in regular broadcast reception.

The wire lead from the "A—" terminal to the battery, has a clip attached to it, in order to disconnect the battery; this acts as a switch.

The set can be tested for oscillation

(Continued on page 366)

GET A CONVERTER FREE!

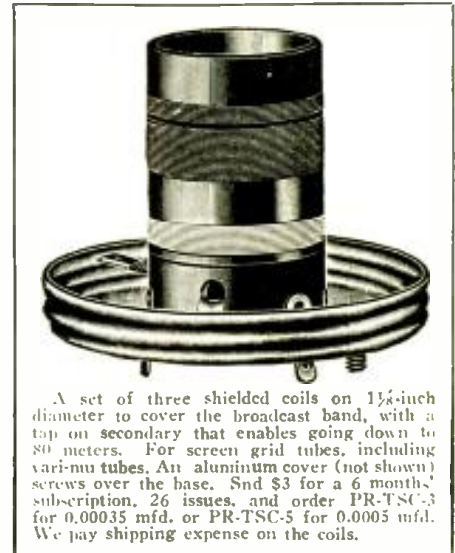

A set of three shielded coils on 1 1/8-inch diameter to cover the broadcast band, with a top on secondary that enables going down to 80 meters. For screen grid tubes, including vari-mu tubes. An aluminum cover (not shown) screws over the base. Send \$3 for a 6 months' subscription, 26 issues, and order PR-TSC-3 for 0.00035 mfd. or PR-TSC-5 for 0.0005 mfd. We pay shipping expense on the coils.

HERE at last you have it—a highly sensitive short-wave converter, 15 to 200 meters, that works on *any* set and that has its own A, B and C supply built in and that does not use plug-in coils for band shifting.

Two separate tuning condensers and two dials are used, so there *can not* be any possibility of sensitivity loss due to mistuning, as where ganging prevails. Also, any intermediate frequency may be used.

The little extra effort in tuning is well repaid by thousands of miles of extra reception. Stations all over the world have been tuned in, using this converter with a good broadcast set.

There are only three connections to make in teaming up the converter with a receiver.

Two coils are used, one for oscillator, the other for modulator, and two tube sockets are near these coils, underneath the top panel, not for tubes but so that you can move the flexible grid connecting wire of the two condensers to any one of four points for wave shifting. Simple, effective, inexpensive.

Three 237 tubes are used. These are of the automotive series and are most economical, the total consumption, A and B power being less than 10 watts, hence costing no more than one-tenth of a cent per hour to operate!

This converter works on superheterodynes as well as on tuned radio frequency sets, because **IF ANY CONVERTER IS A GOOD ONE IT IS BOUND TO WORK ON ANY TYPE OF SET.**

There are 16 mfd. of filter capacity and a 15 henry B choke, in the B supply, as well as a husky line transformer.

Do not suppose just because the offer of these parts is generous that this converter does not perform efficiently, for it is a knockout! What sensitivity! What power! What results! Send \$12 today for a 2-year (104 issues) subscription for RADIO WORLD and get the parts for this converter free (less tubes). Order PR-NCV. A clear diagram is furnished with each kit. Note the kit is not wired. Shipments made by express at your expense. Order Cat. R-CNV.

TUBES USED: Three 237, supplied extra at \$3.50, if desired. No subscription offer attaches to the tubes.



Your Choice of NINE Meters!

To do your radio work properly you need meters. Here is your opportunity to get them at no extra cost. See the list of nine meters below. Heretofore we have offered the choice of any one of these meters free with an 8-weeks' subscription for RADIO WORLD, at \$1, the regular price for such subscription. Now we extend this offer. For the first time you are permitted to obtain any one or more or all of these meters free, by sending in \$1 for 8-weeks' subscription, entitling you to one meter; \$2 for 16 weeks, entitling you to two meters; \$3 for 26 weeks, and three meters; \$6 for 52 weeks, entitling you to six meters. Return coupon with remittance, and check off desired meters in squares below. We pay shipping expense on the meters.

RADIO WORLD, 145-G West 45th Street, New York, N. Y. (Just East of Broadway)

Enclosed please find \$.....for.....weeks subscription for RADIO WORLD and please send as free premium the meters checked off below.

I am a subscriber. Extend my subscription. (Check off if true.)

- 0-6 Voltmeter D.C. No. 326
- 0-50 Voltmeter D.C. No. 337
- 6-Volt Charge Tester D.C. No. 23
- 0-10 Amperes D.C. No. 328
- 0-25 Milliamperes D.C. No. 325
- 0-50 Milliamperes D.C. No. 350
- 0-100 Milliamperes D.C. No. 390
- 0-300 Milliamperes D.C. No. 399
- 0-400 Milliamperes D.C. No. 394
- Enclosed find \$12 for 2 yrs. subs. Send PR-NCV.
- Enclosed find \$6 for 1 yr. subs. Send PR-3B.
- Enclosed find \$3 for 6 mo. subs. Send PR-TSC-3.
- Enclosed find \$3 for 6 mos. subs. Send PR-TSC-5.

NAME

ADDRESS

CITY..... STATE.....

PARTS FOR A MIDGET CONVERTER

No matter what type of broadcast receiver you have, you can get short waves by using a midget short-wave converter built of parts we can supply. The panel is only 5 x 6 1/2 inches. There is only one tuning control. No squeals, howls or body capacity. This model is available for battery operation and uses three 227 tubes with heaters in series. Full details supplied with order.

All parts for the battery model (less three 227 tubes), free with a year's subscription for Radio World at \$6.00. Order PR-3B.

The three 227 tubes can be supplied at \$2.00. No subscription goes with tubes. Converter shipping charges must be paid by you.

RADIO WORLD (10TH YEAR)

115-G West 45th Street, New York, N. Y.



— no greater magazine published on **TELEVISION**

4-color cover



NOW
25c
A COPY

Features :

- Editorial, by Hugo Gernsback.
- What England Has Done With Television, by H. J. Barton Chapple.
- Television in the Theatre a Reality!
- The Future of Television—As I See It, by William S. Paley, President Columbia Broadcasting System.
- John Logie Baird Speaks His Mind—As Told to H. Winfield Secor.
- Short Wave Television at Doberitz, by Herbert Rosen.
- A Cathode Ray Scanner Anyone Can Build, by M. Rappaport, E.E.
- Prize-Winning Television Receiver in N. Y. "Sun" Contest.
- Make Your Own Lens Disc, by Wolf S. Pajes, Television Engineer.
- What of the Television Business? by William H. Pries.
- Are You Ready to Receive 5 Meter Television Signals? by C. H. W. Nason.
- What Happens in a Cathode Ray Tube, by W. Zeitlin.
- New Jenkins Apparatus.
- The Design of a Complete Television System, by C. E. Huffman.
- The "Magnalite" Tube, by Henri F. Dapayrat.
- The Ultimate Receiver for Television.

OVER 200 ILLUSTRATIONS, DIAGRAMS, CIRCUITS AND PHOTOGRAPHS—Actual Photographs of Television Transmitters and Receivers.

Rush Coupon TODAY!

TELEVISION NEWS SWC-2-5
98 Park Place, New York, N. Y.

As per your special offer, I enclose herewith \$1.25 (Canadian and foreign \$1.50) for which enter my subscription to TELEVISION NEWS for One Year.

Name
Address
City State

The Best Short-Wave Converter

(Continued from page 319)

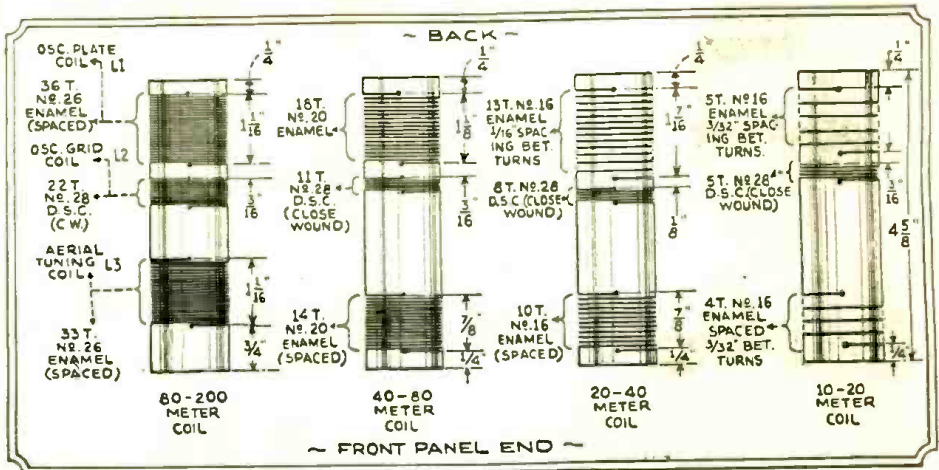

Converter Coil Data—2 coils at left 1 1/4" O.D.; 2 coils at right 7/8" O.D. (Outside diameter.)

adjusting the set when "dead spots" are encountered.

The R.F. choke built and tried out in the original converter has about 1 millihenry inductance, comprising 100 turns No. 29 D.S.C. magnet wire, wound on a bakelite tube or rod 7/8 inch in diameter.

List of Parts

- 1—"Best" short wave coil and switch assembly, including calibrated escutcheon plate.
- 1—Two-gang Hammarlund midget condenser; each unit 140 mmf.
- 1—Hammarlund midget condenser, 80 mmf.
- 1—Hammarlund equalizer condenser, screw type, 80 mmf.
- 1—Shield box, 6 by 7 by 10 inches (Blan).
- 2—Tubes—one '27 and one '24.
- 2—UY-5 prong sockets.
- 1—Five prong plug.
- 3—.006 mf. bypass condensers—Flechtheim
- 1—.001 mf. bypass condenser—Flechtheim.
- 1—10,000 ohm, 1 watt resistor—Electrad or other make.
- 1—60,000 ohm, 1 watt resistor—Electrad or other make.
- 1—6,500 ohm, 1 watt resistor—Electrad or other make.
- 1—R.F. choke wound as specified, or 85 M.H. Hammarlund (as used in model here illustrated).
- 1—National Baby vernier dial.

Among the "Hams"

(Continued from page 343)

It may also interest you to know that I was an "out-and-out" greenhorn at this radio game and never had any assistance whatsoever, excepting from magazine articles, which just goes to show would-be-hams that it just needs a start. Short wave work is a real human hobby and there is no end to the scope it affords. Amateurs the world over occasionally get opportunities to prove their usefulness to their community. I enjoy listening to amateurs on 20/21 meter band and have heard them from all over the states, even in "Sunny California".

Wishing you an increased circulation with every issue and good luck.

Sincerely yours and many thanks,
WILLIAM H. STEWART, JR.
414 Elm Ave.,
Windsor, Ontario, Canada.

(Well, Bill H., all we can say is that you are not so much of a "greenhorn" anymore, if your present letter is any indication at all. We fully agree with you that short wave work is a real he-man's hobby.)

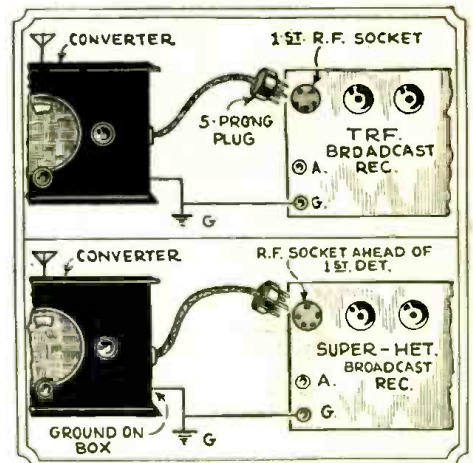

How to plug in converter.

A Simple "Amateur Band" Receiver

(Continued from page 364)

by touching the grid of the detector tube with the finger; if a click is heard, the set is oscillating.

If no click is heard, after bringing the regeneration control to its maximum, or increasing the plate voltage of the detector, the tickler may be connected wrong, or possibly has not a sufficient number of turns.

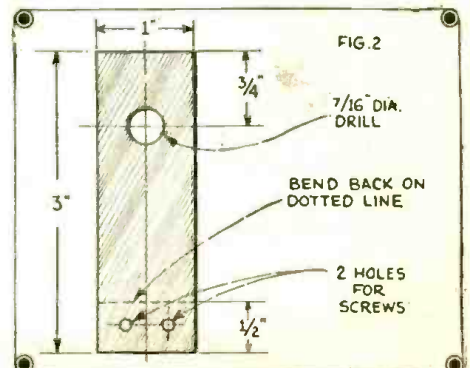

Detail of mounting bracket.

Over **25,000 Men**
have been trained under my supervision for the
Better Jobs
in RADIO



PROOF

R. L. DUNCAN, *President*
 Radio Training Schools



As a graduate and a student under your supervision, I have only the highest praise and satisfaction to offer. Any man of ordinary intelligence wanting to learn Radio could not help but master it by your method of training.
 GEORGE A. KRESS,
 2907 Montclair Ave., Detroit, Michigan



I am a Projectionist in charge at the Andalus theatre, recently completed. You may quote me at any time or place; refer to me, if you wish, anyone who may be interested in this vast virgin field of all that pertains to Radio and its many allied industries, and I shall be delighted to champion honestly without any reservation, your courses.
 A. H. STRENGE,
 505 Woodburn Ave., Cincinnati, Ohio.



To study Radio under R. L. Duncan is to learn it properly and in a way that is pleasant and fascinating. Once again thank you for your kind assistance and helpfulness.
 E. E. PRICE,
 251 Coburn St., W.,
 Moose Jaw, Sask., Canada.



Although it has not yet been a year since I enrolled for a course under your excellent supervision, I have opened a Radio Service Shop that is effective, successful and profitable. People come for my services from everywhere.
 RUSSELL PEARCE,
 330-15th Street, Des Moines, Iowa.

IN hundreds of Broadcasting Stations . . . in Radio Manufacturing Plants throughout the country . . . in Radio Laboratories . . . in Wholesale and Retail Radio Stores . . . in Radio Servicing . . . in Sound Motion Picture activities . . . on hundreds of ships that sail the Seven Seas . . . and even in the latest Television developments—you will find ambitious men who have been trained under my direct supervision.

I have devoted the last twelve years exclusively to the training of men for all branches of Radio. Employers in the Radio field recognize my methods of qualifying men and young men. I have geared my training to the rapid growth and development of the Radio industry. My courses, text books, methods and equipment are based on years of practical experience.

And now, with the organization of my own *independent* Radio Training Schools, Inc., I am better prepared to help you than ever before, in training for the opportunities which the future of the ever-growing Radio industry will have to offer.

You too can train for Future Success in Radio

The next few years will offer more prospects than ever before. The past several months offer positive proof that the trained man has the best chance. You still can get that training which will qualify you to gain a foothold in Radio. Study at home, in spare time, at minimum expense. Earn while you learn. Capitalize your idle and spare time and reap the benefits of a trained man in a progressive industry—Radio.

Make your Idle and Spare Time Profitable

My courses include everything needed for thorough training. There are no "extras" or "specials" to cost you extra money. The lessons, text books, methods, correcting, grading and returning of examinations, all the extra help and personal consultation you need . . . everything is provided until you complete your training.

RADIO TRAINING SCHOOLS, INC.
 326 Broadway New York City

And in addition you are assured *practical* as well as theoretical training.

Pick Your Branch of Radio

I am offering four distinct Radio training courses:

1. Talking Motion Pictures—Sound
2. Radio and Broadcast Operating
3. Practical Radio Engineering
4. Radio Service and Mechanics

Each course is complete. Each starts out with simple principles well within your grasp. Each is right up to date, including latest developments such as Television. Each prepares you for a good paying position. Each leads to a Certificate of Graduation.

Advanced Training for Radio Men

My Practical Radio Engineering Course is an advanced course intended for Radio men who want to go still higher. It provides that necessary engineering background which, combined with practical experience, qualifies the man for the topmost job.

Ask for Facts—Write Now!

Let me sit down with you for an hour or two at your convenience. Let's go over the possibilities in Radio. This we can best do by means of the book I have just prepared. It covers the many branches of Radio and the kind of training required. Be sure to get your copy . . . it is free.



Mr. R. L. DUNCAN, *President* Dept. SW-2
 Radio Training Schools, Inc.
 326 Broadway, New York City

Without incurring the slightest obligation on my part, please send me a copy of your latest book, "Facts About Radio."

Name -----
 Address -----
 City ----- State -----





J. E. Smith, President, National Radio Institute, the man who has directed the Home-Study training of more men for the Radio Industry than any other man in America.

YOU'RE WANTED *for a* Big Pay Radio Job

I'll Train You at Home in Your Spare Time for RADIO · TELEVISION · TALKING MOVIES



Set Servicing

Spare-time set servicing is paying N. R. I. men \$200 to \$1,000 a year. Full-time men are making as much as \$65, \$75 and \$100 a week.



Broadcasting Stations

Need trained men continually for jobs paying \$1,200 to \$5,000 a year.



Ship Operating

Radio operators on ships see the world free and get good pay plus expenses.

Aircraft Radio

Aviation is needing more and more trained Radio men. Operators employed through Civil Service Commission earn \$1,620 to \$2,800 a year.

IF YOU are earning a penny less than \$50 a week, send for my book of information on the opportunities in Radio. It is free. Clip the coupon NOW. Why be satisfied with \$25, \$30 or \$40 a week for longer than the short time it takes to get ready for Radio?

Radio's Growth Opening Hundreds of \$50, \$75, \$100 a Week Jobs Every Year

In about ten years Radio has grown from a \$2,000,000 to a \$1,000,000,000 industry. Over 800,000 jobs have been created. Hundreds more are being opened every year by its continued growth. Men and young men with the right training—the kind of training I give you—are stepping into Radio at two and three times their former salaries. J. A. Vaughn, Grand Radio & Appliance Co., 3107 S. Grand Boulevard, St. Louis, Mo., writes: "Before I entered Radio I was making \$35 a week. Last week I earned \$110 selling and servicing sets. I owe my success to N. R. I."

You Have Many Jobs To Choose From

Broadcasting stations use engineers, operators, station managers and pay \$1,200 to \$5,000 a year. Manufacturers continually need testers, inspectors, foremen, engineers, service men, buyers, for jobs paying up to \$7,500 a year. Radio Operators on Ships enjoy life, see the world with board and lodging free, and get good pay besides. Dealers and jobbers employ service men, salesmen, buyers, managers, and pay \$30 to \$100 a week. There are many other opportunities too.

So Many Opportunities Many N. R. I. Men Make \$200 to \$1000 While Learning

The day you enroll with me I'll show you how to do 28 jobs, common in most every neighborhood, for spare-time money. Throughout your course I send you information on servicing popular makes of sets; I give you the plans and ideas that are making \$200 to \$1,000 for hundreds of N. R. I. students in their spare time while studying. My course is famous as the one that pays for itself. G. W. Page, 2210 Eighth Ave., S., Nashville, Tenn., writes: "I picked up \$935 in my spare time while taking your course."

Special training in Talking Movies, Television and Aircraft home Television experiments. Radio's use in Aviation, Servicing and Merchandising Sets, Broadcasting, Commercial and Ship Operating are included. I am so sure that I can train you satisfactorily that I will agree in writing to refund every penny of your tuition if you are not satisfied with my Lessons and Instruction Service upon completing.

Talking Movies, Television and Aircraft Radio are Also Included

64-page Book of Information Free

Get your copy today. It tells you where Radio's good jobs are, what they pay, tells you about my course, what others who have taken it are doing and making. Find out what Radio offers you, without the slightest obligation. ACT NOW!

J. E. SMITH, President
National Radio Institute
Dept. 2BB3
Washington, D. C.



THIS COUPON IS GOOD for
One FREE COPY OF *mail it*
MY BOOK **Now**

J. E. SMITH, President
National Radio Institute, Dept. 2BB3
Washington, D. C.

Dear Mr. Smith:
I want to take advantage of your Special Offer. Send me your two books "The Principles of Television" and "Rich Rewards in Radio". I understand this does not obligate me and that no salesman will call.

Name.....
Address.....
City..... State.....

Special Free Offer



"The Principles of Television"

For the first time this authoritative book on Television is made available to the general public. Until now only my students could have it. Act promptly, and I'll send you a copy FREE in addition to my big free book "Rich Rewards in Radio." This book on Television gives you the fundamental facts about Television, its status, a comparison of sound and visual communication, and describes in detail the typical devices used in the six fundamental steps of Television. Get the facts about this coming field of great opportunity. Mail the coupon NOW.

Convince the Skeptics!



Recordovox outfit, consisting of recorder-reproducer head, three weights, control box and adapters..... **\$27.50**
Hand microphone..... **\$10.00**

PROVE that you heard those foreign stations

Do you get the well-known horse laugh from your friends when you tell them that you have heard voice and music direct from England, France, Japan or Australia on the short waves? Do they cast aspersions on your veracity? Or do they call you a plain, unfancy liar?

Well, you can't blame them much for being unbelievers, but you can convince them quiet easily that you're telling the truth even if you are a DX fan. *Record the programs when you hear them and then let the skeptics hear the evidence with their own ears!*

The new Pacent RECORDOVOX makes this stunt easy. Just slip simple adapters under the detector and audio output tubes and mount the combination pick-up and recorder on the phonograph turntable. Five minutes' effort and you are ready to begin recording on inexpensive Victor records. Works with

any radio receiver using a 171A or larger tube in the output stage, and with any phonograph.

With the RECORDOVOX you can also make home records of voice, music and ordinary radio programs, and play them back without taking them off the turntable. Handles all regular commercial records, of course. Position of hand microphone in circuit allows you to insert your own announcements into radio programs. Assures the success of any party!

New RECORDOVOX outfit consists of reproducer and recorder head, with three weights for recording, a small, neat control box, and necessary adapters and cables. Two knobs on control box, one for volume control of phonograph reproduction, the other for shifting between radio, recording, reproducing and announcing. May be left installed permanently, or can be transferred from short-wave to broadcast receiver in less than a minute.

Pacent's wonderful record of twenty years in the radio and electrical reproduction field is your guarantee of quality in manufacture and satisfaction in performance.

PACENT ELECTRIC CO., Inc.

91 Seventh Avenue, New York, N. Y.

The PILOT Short Wave Converter Adds These 5 Interesting Wave Bands to Your Present Broadcast Receiver

Brings in
Foreign Stations on the
Loud Speaker

No Coils to Change

PILOT
Short
Wave
Converter



Self-
Contained
Self-
Energized

Price, complete with four tubes,
ready to operate (no kits;
in factory built form only)...

\$39.50

Connects in 2 Minutes
With 2 Simple Wires—
Nothing to Disturb

Uses two 224A's, one 227, one 280. Operates as a superheterodyne frequency changer. Works with any TRF or super-het broadcast receiver; affords enormous amplification with knife edge selectivity. Five wave ranges covered by the twist of a knob. Single dial tuning with non-critical antenna trimmer. Opens the whole absorbing field of short wave radio to any member of the family old enough to turn a knob.

Also a Complete Combination Set— The New PILOT SUPER-WASP

Complete with 11 tubes,
ready to operate (no kits;
in factory built form
only)

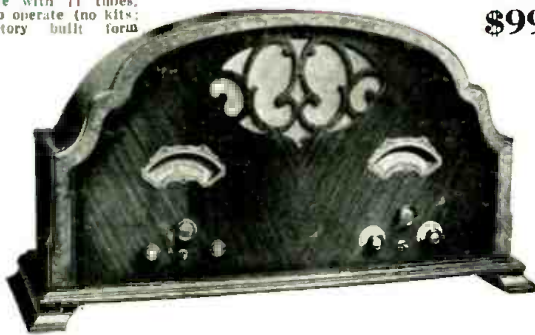

\$99.50

The 1932 SUPER-WASP—the latest model of the internationally famous receiver for short wave and broadcast reception. On the short waves it is a double superheterodyne of eleven tubes, working on two intermediate frequencies: 559 kc. and 175 kc. Has full throated dynamic speaker. Brings in the foreign stations with unbelievable volume.

YOUR DEALER

Can Supply

You With

PILOT

SHORT WAVE

and

BROADCAST

SETS

Band One: 10 to 19 Meters

Alive during morning hours with American and foreign radio telephone and short wave relay broadcasting stations. It's great sport to hear London, Berlin and Buenos Aires talking to New York; or Eindhoven (Holland) conversing with Sourabaya (Dutch East Indies).

Band Two: 19 to 35 Meters

After lunch, skip up to band two and hear Chelmsford, England; Pointoise, France; or Königswusterhausen Germany. Also ship-to-shore radio telephones, and American and Canadian broadcasters. Rome may be on with an opera, or Mexico City with a news report.

Band Three: 35 to 65 Meters

Always a source of thrills. Dozens of North American, Central American and South American broadcasters, easily heard during the early evening. Entertain your guests with music from Costa Rica and Colombia, from California and Canada.

Band Four: 65 to 110 Meters

Actually hundreds of amateur phone stations, all over the country, operate in this band. You can listen to them for hours. Also airport and airplane stations, which are heard at all hours of the day and night.

Band Five: 110-200 Meters

Nothing is more thrilling than to hear the police radio stations directing "cruiser" cars to scenes of crimes or accidents. You live with the news while it is happening! Experimental television stations are also in this band.

PILOT RADIO AND TUBE CORPORATION, LAWRENCE, MASS.

- Please send me full technical "dope" on the new Pilot Short Wave Converter and the new complete Super-Wasp. Free, no obligation on my part.
- Please send me a free sample copy of Radio Design.
- Enclosed is 50c. Enter my subscription to Radio Design for one year.

Name Street and Number

City State SWC

